

CATÁLOGO

ACCESORIOS VARIOS

EDICIÓN CAV-13-02

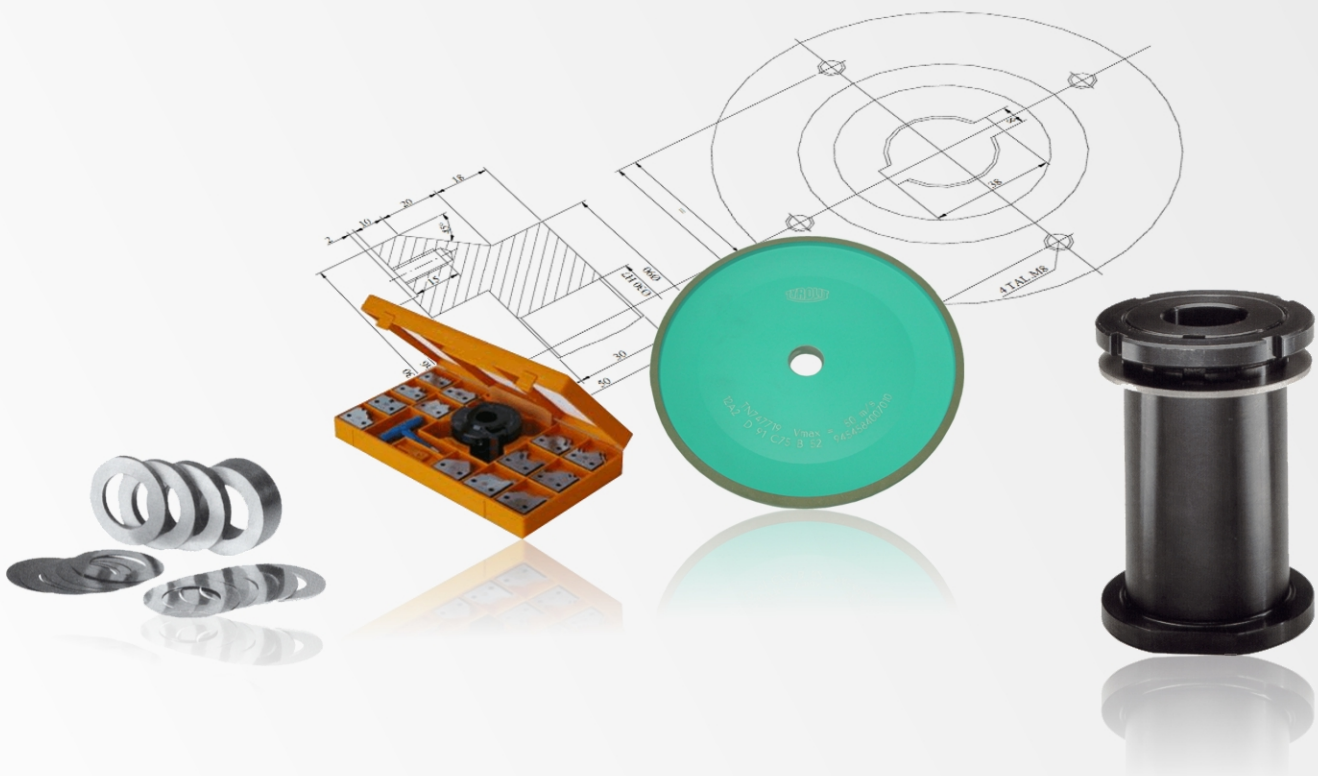

ÍNDICE

ACCESORIOS Y VARIOS

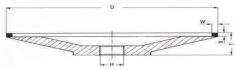
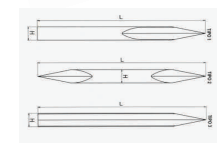
**MUELAS DE DIAMANTE Y BORAZÓN****PAG. 229-231****MUELAS CERÁMICAS AFILADO CINTAS Y FRESAS****PAG. 232-233****SIERRAS DE CINTA****PAG. 234-235****CADENAS DE ESCOPEAR****PAG. 236-239****ESTUCHE CUCHILLAS PERFILADAS OMAS****PAG. 240-243****ESTUCHE CUCHILLAS PERFILADAS****PAG. 244-254****CUCHILLAS PARA TORNO****PAG. 255****ANILLOS REDUCCIÓN PARA DISCOS Y FRESAS****PAG. 256-257****ANILLOS SEPARADORES - RODAMIENTOS****PAG. 258-260****HUSILLOS PORTA HERRAMIENTAS****PAG. 261-263**

ÍNDICE

ACCESORIOS Y VARIOS



AFILADORES MANUALES DE DIAMANTE

PAG. 264



MEDIDOR DE ÁNGULOS

PAG. 265

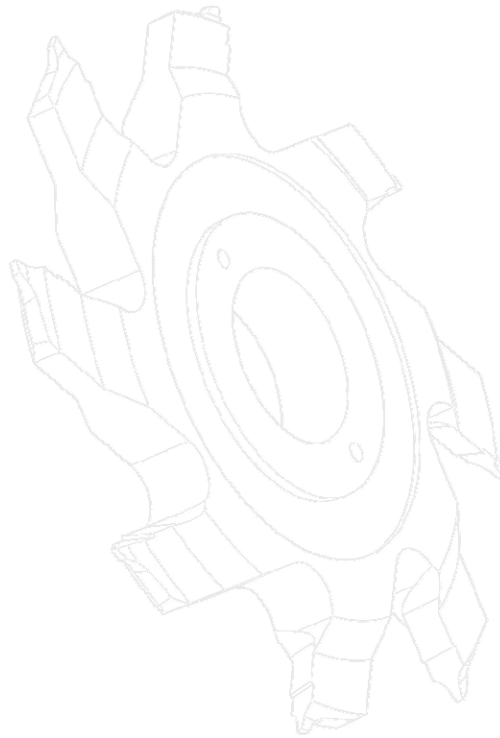

MUELA FORMA 12A2 PARA AFILADO DE FRESAS

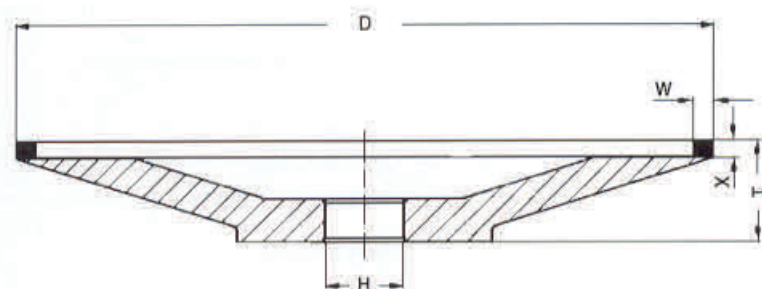

Ø ext	Ø int	banda W x X	TIPO DE AFILADO	CARACTERISTICAS TECNICAS	REFERENCIA	PVP
125	20	5 x 3	seco - humedo	DIAMANTE D 126 C 75 B 53	0121012502012675	B 49
125	20	5 x 4	seco - humedo	DIAMANTE D 64 C 50 B 73	0121012502006450	C 12
125	20	5 x 4	seco - humedo	BORAZON B 126 C 50 B 57	0121112502012620	C 20
150	20	5 x 4	seco - humedo	DIAMANTE D 91 C 50 B 52	0121015002009150	C 15
150	20	5 x 4	seco - humedo	DIAMANTE D 64 C 75 B 42	0121015002006475	C 25
150	20	5 x 2	seco - humedo	BORAZON B 126 C 50 B 54	0121115002012650	B 49
150	20	5 x 4	seco - humedo	BORAZON B 126 C 75 B 53	0121115102012650	C 43

MUELA FORMA 4A2 PARA AFILADO DE DISCOS

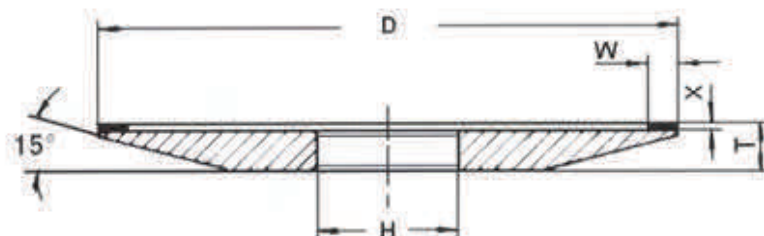

Ø ext	Ø int	banda W x X	TIPO DE AFILADO	CARACTERISTICAS TECNICAS	REFERENCIA	PVP
125	20	5 x 2	seco - humedo	DIAMANTE D 64 C 50 B 73	0121012502006450	B 47
125	32	3 x 2	seco - humedo	DIAMANTE D 64 C 50 B 52	0121012503206450	B 44
150	20	5 x 2	seco - humedo	DIAMANTE D 91 C 50 B 52	0121015002009150	B 41

ESPECIFICACIONES PARA MUELAS.

DIAMANTE. Para afilado de metal duro

BORAZÓN. Para afilado de acero rápido y Tantan (TT)

D= Tamaño del grano de la muela

C= Concentración de granos de la muela

B= Aglomerante o liga producto que sujeta el grano

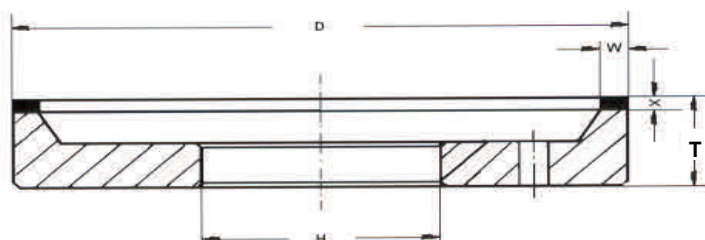
MUELA FORMA 6A2 PARA AFILADO DE CUCHILLAS

Ø ext	Ø int	T	banda W x X	TIPO DE AFILADO	CARACTERISTICAS TECNICAS	REFERENCIA	PVP
100	16	40	6 x 5	seco - humedo	DIAMANTE 11D91 C 75 B 74	0121010001609175	C 45
125	16	40	6 x 5	seco - humedo	DIAMANTE 11D91 C 75 B 74	0121012501609175	C 47
125	16	40	6 x 5	seco - humedo	BORAZON 51B 126 C 60 B 54	0121112501612654	D 7
150	20	45	8 x 4	seco - humedo	DIAMANTE D 107 C 60 B 53	0121015002010753	C 47
150	20	45	8 x 4	seco - humedo	BORAZON B151 C 75 B 54	0121115002015175	D 7

MUELA FORMA 1A1 PARA PERFILADORAS WEINING RONDAMAT

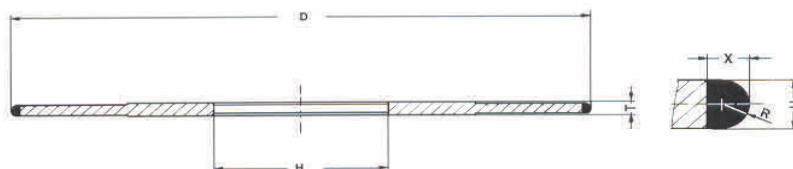

Ø ext	Ø int	banda W x X	TIPO DE AFILADO	CARACTERISTICAS TECNICAS	REFERENCIA	PVP
150	60	10 x 3	seco - humedo	DIAMANTE D 151 C 50 B42	0121015006015150	D 5
150	60	10 x 3	seco - humedo	BORAZON B 151 C 50 B 73	0121115006015150	D 20

MUELA FORMA 14F1 PARA PERFILADORAS WEINING RONDAMAT

Ø ext	Ø int	R	banda W x X	TIPO DE AFILADO	CARACTERISTICAS TECNICAS	REFERENCIA	PVP
200	60	1,0	2 x 5	humedo	DIAMANTE DE 1263BV STARTEC	0121020006000210	D 5
200	60	1,0	2 x 5	humedo	BORAZON 51B 126 C 100 B 73 AL	0121120006000210	D 25
200	60	1,5	3 x 5	humedo	DIAMANTE DE 1263BV STARTEC	0121020006000315	D 10
200	60	1,5	3 x 5	humedo	BORAZON 51B 126 C 100 B 73 AL	0121120006000315	D 42
200	60	2,0	4 x 5	humedo	DIAMANTE DE 1263BV STARTEC	0121020006000420	D 30
200	60	2,0	4 x 5	humedo	BORAZON 51B 126 C 100 B 73 AL	0121120006000420	E 13

PARA OTRAS MEDIDAS Y CARACTERÍSTICAS CONSULTAR

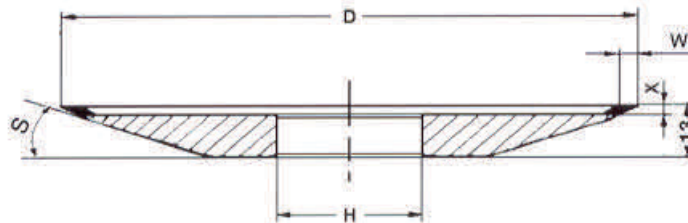
MUELA FORMA 4V2 PARA AFILADO DEL INTERIOR DISCOS MÁQUINAS AUTOMÁTICAS



Ø ext	Ø int	banda W x X	MAQUINA	TIPO DE AFILADO	CARACTERISTICAS TECNICAS	REFERENCIA	PVP
100	32	4 X 2	VOLLMER	humedo	DIAMANTE D 64 C 125 B 74	01210100032064125	C 4
125	32	4 X 2	VOLLMER	humedo	DIAMANTE D 64 C 125 B 74	01210125032064125	C 10
150	32	4 X 2	AKE	humedo	DIAMANTE D 76 C 125 B 74	01210150032076125	C 14

MUELA FORMA 3M1Z AFILADO DEL DIAMETRO DISCOS EN MÁQUINAS AKE AKE

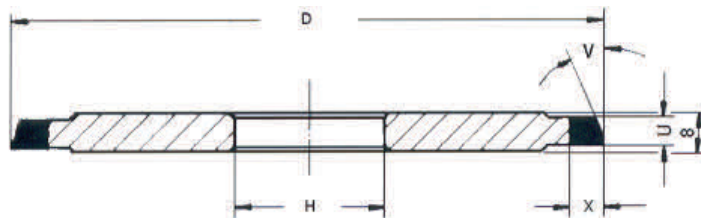

Ø ext	Ø int	banda W x X	TIPO DE AFILADO	CARACTERISTICAS TECNICAS	REFERENCIA	PVP
125	32	8 X 5	humedo	DIAMANTE D 126/64 C 100/75 B 68	01210125032064100	D 5

MUELA FORMA 12A9Z AFILADO DEL DIAMETRO DISCOS EN MÁQUINAS VOLLMER

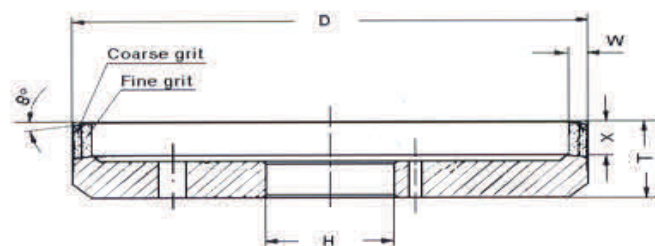

Ø ext	Ø int	banda W x X	TIPO DE AFILADO	CARACTERISTICAS TECNICAS	REFERENCIA	PVP
100	25	6 X 10	humedo	DIAMANTE D 126/46 C 100/75 B 63/65	01210100032126125	C 32
125	32	6 X 5	humedo	DIAMANTE D 126/46 C 100/75 B 63/65	01210125032126125	C 19
125	32	6 X 10	humedo	DIAMANTE D 126/46 C 100/75 B 63/65	01210150032076125	C 32

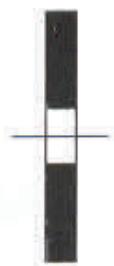
MUELAS BORDES RECTOS SIN BISELAR

MEDIDAS	ESPECIFICACIONES	REFERENCIA	PVP
200 x 8 x 20	89A 60 M5A V217	0121220002000801	A 28
200 x 8 x 32	89A 60 K5A V217	0121220003200801	A 28
200 x 8 x 32	89A 60 M5A V217	0121220103200801	A 28
200 x 10 x 20	89A 60 M5A V217	0121220002001001	A 29
200 x 10 x 32	89A 60 K5A V217	0121220003201001	A 29
200 x 10 x 32	89A 60 M5A V217	0121220103201001	A 29
225 x 10 x 32	89A 601 L5A V217	0121222503201001	A 33
250 x 8 x 20	89A 60 M5A V217	0121225002000801	A 34
250 x 8 x 32	89A 60 M5A V217	0121225003200801	A 34
250 x 10 x 20	89A 60 M5A V217	0121225002001001	A 36
250 x 10 x 32	89A 60 K5A V217	0121225003201001	A 36
250 x 10 x 32	89A 60 M5A V217	0121225103201001	A 36
250 x 12 x 20	89A 60 M5A V217	0121225002001201	A 39
250 x 12 x 32	89A 60 M5A V217	0121225003201201	A 39
250 x 13 x 20	89A 60 M5A V217	0121225002001301	A 39

**MUELAS BORDES RECTOS SIN BISELAR
CON CANTO ENDURECIDO**

MEDIDAS	ESPECIFICACIONES	REFERENCIA	PVP
200 x 10 x 32	89A 60 M5A V217 4A	0121220003201002	A 30
200 x 12 x 32	89A 60 M5A V217 4A	0121220003201202	A 31
225 x 10 x 32	89A 60 M5A V217 4A	0121222503201002	A 36
225 x 12 x 32	89A 60 M5A V217 4A	0121222503201202	A 38
250 x 10 x 32	89A 60 M5A V217 4A	0121225003201002	A 39
250 x 12 x 32	89A 60 M5A V217 4A	0121225003201202	A 42
250 x 13 x 20	52A 54 M5A V217 4A	0121225002001302	A 43

MUELAS CON DOS BANDAS DE DISTINTA DUREZA Y UN BORDE CON BISEL

MEDIDAS	ESPECIFICACIONES	REFERENCIA	PVP
175 x 8 x 20	88A 60 N4A V217 / 89A 60 M5A V217	0121217502000803	A 29
175 x 10 x 20	88A 60 N4A V217 / 89A 60 M5A V217	0121217502001003	A 31
200 x 10 x 20	88A 60 N4A V217 / 89A 60 M5A V217	0121220002001003	A 32
200 x 12 x 20	88A 60 N4A V217 / 89A 60 M5A V217	0121220002001203	A 34
200 x 12 x 32	88A 60 N4A V217 / 89A 60 M5A V217	0121220001203203	A 34
250 x 10 x 20	88A 60 N4A V217 / 89A 60 M5A V217	0121225002001003	A 40

MUELAS AGLOMERANTE CERAMICO FORMA 6 PARA AFILADO DE CUCHILLAS HSS



Ø ext	Ø int	ALTO	PARED	TIPO DE AFLADO	CARACTERISTICAS TECNICAS	REFERENCIA	PVP
80	20	40	W 6	SECO - HUMEDO	89A 60 K5A V 53	0121208002004006	A 22
100	20	50	W10	SECO - HUMEDO	88A 60 L5 V 53	0121210002005010	A 31
100	20	50	W10	SECO - HUMEDO	89A 60 M5A V 53	0121210002005011	A 31
125	20	50	W12	SECO - HUMEDO	88A 70 K5 V 53	0121212502005012	A 38
150	20	70	W17	SECO - HUMEDO	89A 36 J7 V 217	0121215002007017	B 2
150	50	80	W10	SECO - HUMEDO	89A 46 H7A V 53	0121215005008010	B 2
165	20	76	W17	SECO - HUMEDO	88A 36 H8 V 217	0121216502007617	B 12
175	76,2	75	W17	SECO - HUMEDO	89A 36 J8 V 217	0121217507607517	B 17

MUELAS AGLOMERANTE CERÁMICO FORMA 12 PARA AFILADO DE FRESAS HSS



Ø ext	Ø int	TIPO DE AFLADO	CARACTERISTICAS TECNICAS	REFERENCIA	PVP
100	20	SECO - HUMEDO	89A 60 1J5A V53	0121210002000000	A 20
150	20	SECO - HUMEDO	89A 60 1J5A V53	0121215002000000	A 25
200	20	SECO - HUMEDO	89A 60 H5A V53	0121220002000000	A 34

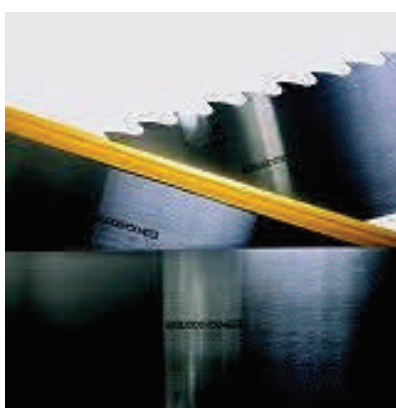

ANCHO	ESPESOR	PASOS	PVP METRO	SOLDADURA	AFLADO Y LIZADO
6	0,4	6	A9	A5	NO NECESITAN
6	0,65	6	A8	A5	NO NECESITAN
10	0,65	6 - 8	A8	A5	NO NECESITAN
13	0,65	6 - 8	A9	A5	NO NECESITAN
10	0,4	6 - 8	A2	A5	A 14
10	0,5	6 - 8	A2	A5	A 14
10	0,6	6 - 8	A2	A5	A 14
10	0,7	6 - 8	A2	A5	A 14
12	0,6	6 - 8 - 10	A2	A5	A 14
12	0,7	6 - 8 - 10	A3	A5	A 14
16	0,4	6 - 8 - 10	A2	A5	A 14
16	0,5	6 - 8 - 10	A2	A5	A 14
16	0,6	6 - 8 - 10	A2	A5	A 14
16	0,7	6 - 8 - 10	A3	A5	A 14
20	0,45	8 - 10 - 12	A3	A5	A 14
20	0,5	8 - 10 - 12	A3	A5	A 14
20	0,6	8 - 10 - 12	A3	A5	A 14
20	0,7	8 - 10 - 12	A3	A5	A 14
25	0,6	8 - 10 - 12	A3	A5	A 14
25	0,7	8 - 10 - 12	A4	A5	A 14
30	0,6	8 - 10 - 12	A4	A6	A 14
30	0,7	8 - 10 - 12	A4	A6	A 14
30	0,8	8 - 10 - 12	A5	A6	A 14
35	0,7	10 - 12 - 14	A6	A6	A 14
35	0,8	10 - 12 - 14	A5	A6	A 14
40	0,8	10 - 12 - 14	A6	A6	A 14
40	0,9	10 - 12 - 14	A7	A6	A 14
45	0,8	14 - 16	A8	A10	A 16
45	0,9	14 - 16	A9	A10	A 16
50	0,9	14 - 16	A11	A10	A 16
50	1,0	14 - 16	A11	A10	A 16
60	0,6	16 - 18 - 20	A12	A10	A 16
60	0,9	16 - 18 - 20	A12	A10	A 16

SIERRAS DE CINTA PARA MÁQUINAS DARIO

MEDIDAS	PVP
2,450 x 06 x 0,65 P 6	A 21
2,450 x 10 x 0,65 P 6	A 21
2,450 x 10 x 0,65 P 8	A 21
2,450 x 13 x 0,65 P 6	A 21

Precio por cinta, lista para trabajar



SIERRAS DE CINTA BIMETALICA PARA CORTE DE MADERAS CON PUNTAS

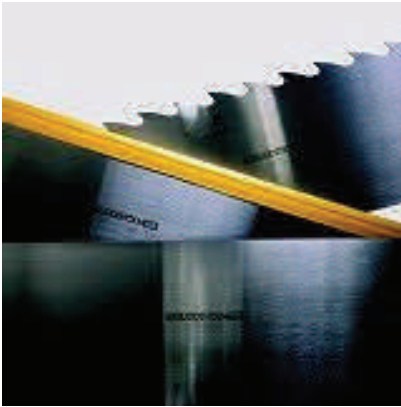

ANCHO	ESPESOR	PASOS	PVP METRO	SOLDADURA	AFILADO Y LIZADO	PVP
13	0,80	6 - 8	A18	A 12	NO NECESITAN	14
20	0,90	6 - 8	A 19	A 12	NO NECESITAN	14
27	0,9	8 - 12	A 19	A 16	NO NECESITAN	14
34	1,1	8 - 12 - 20	A 24	A 17	NO NECESITAN	14
41	1,3	8 - 12 - 20	A 25	A 18	NO NECESITAN	14

Sierras de cinta para corte de maderas viejas, procedentes de casas antiguas, con puntas, restos de barnices, etc.

Estas cintas solo se pueden afilar entre dos y cuatros veces mientras conserven el lizo. Luego se tiran

SIERRAS DE CINTA BIMETALICA M 42 PARA CORTE DE ACERO

Sierras de Cinta Bimetálicas

GOIKARTE M42
[DENTADO VARIABLE]



APLICACIONES

- Todo tipo de aceros hasta 1400 N/mm²
- Para pequeñas y grandes piezas macizas.
- Cortes individuales o en paquete.
- Tubos de pequeñas y grandes secciones.
- Tubos y perfiles de acero inoxidable.
- Perfiles estructurales pequeños y medianos.
- Para todo tipo aplicaciones de taller.



Aceros al carbono, aceros aleados, aceros de herramientas, aceros inoxidables, metales no férricos.

- Sierra bimetálica universal con acero rápido M42 (68 – 69 HRC) en la punta de los dientes, desarrollada para cortar en pequeñas máquinas manuales o semi-automáticas y grandes máquinas de producción.
- El alto contenido en cobalto y molibdeno ofrece una gran resistencia al desgaste y la abrasión en cortes en serie.
- El dentado variable disminuye las vibraciones durante el corte, y mejora el rendimiento y la tenacidad de la hoja en cortes intermitentes susceptibles de choques.

ANCHO	ESPESOR	PASOS	PVP METRO	SOLDADURA
6	0,6	10/14	A 23	A 13
6	0,9	14/16	A 23	A 13
10	0,6	10/16	A 23	A 13
10	0,9	10/16	A 24	A 17
13	0,6	10/16 -8/12-6/10	A 23	A 13
13	0,9	10/16	A 23	A 13
20	0,9	10/16 -8/12-6/10	A 25	A 13
27	0,9	10/16 -8/12-6/10	A 26	A 13
34	1,1	10/16 -8/12-6/10	A 28	A 13

TABLA DE SELECCIÓN DE DENTADO

PASO DIENTE	TUBOS Y PERFILES	MACIZOS
Z - 14	0,2 mm de espesor	0-10 mm
z= 10/14	2-4 mm de espesor	7-12 mm
z = 8/12	3-5 mm de espesor	10-20 mm
z - 6/10	4-7 mm de espesor	15-30 mm
z= 5/8	6-10 mm de espesor	20-40 mm
z= 5/6	no se recomienda	35-90 mm
z=4/6	7-15 mm de espesor	40-100 mm
z 3/4	12-30 mm de espesor	80-160 mm

PRECIO DE CINTAS MAS COMUNES

DIMENSIONES	PRECIO CINTA
1330 x 13 x 0,6	A 33
2070 x 20 x 0,9	A 46
2450 x 27 x 0,9	B 2
2600 x 27 x 0,9	B 3
2750 x 27 x 0,9	B 5
3010 x 27 x 0,9	B 7
4570 x 34 x 1,1	B 25
4600 x 34 x 1,1	B 25
5800 x 41 x 1,3	C 4
6775 x 41 x 1,3	C 16

U Utensilegno

CADENAS PASO A - 22,6 mm

Para taladros de **6 a 40 mm.**
 Grueso x **40 mm**
 Largo x **150 mm** . Profundidad.
CADENA DE 36 MALLAS

DIMENSIONES	PVP JUEGO COMPLETO	PVP CADENA	PVP BARRA GUIA	PVP PIÑON	PVP COJINETE+TAPAS	PVP J. MALLAS
6 x 40 x 150	C 50	B 36	B 40	A 26	A 45	A 14
7 x 40 x 150	C 50	B 36	B 40	A 26	A 45	A 14
8 x 40 x 150	C 50	B 37	B 40	A 26	A 45	A 14
9 x 40 x 150	D 1	B 35	B 41	A 26	A 45	A 15
10 x 40 x 150	D 1	B 35	B 41	A 26	A 45	A 15
11 x 40 x 150	D 3	B 39	B 41	A 26	A 45	A 15
12 x 40 x 150	D 7	B 41	B 43	A 26	A 45	A 15
13 x 40 x 150	D 7	B 41	B 43	A 26	A 45	A 15
14 x 40 x 150	D 9	B 43	B 43	A 26	A 45	A 15
15 x 40 x 150	D 9	B 43	B 43	A 26	A 45	A 15
16 x 40 x 150	D 10	B 46	B 43	A 26	A 45	A 16
17 x 40 x 150	D 13	B 49	B 43	A 26	A 45	A 16
18 x 40 x 150	D 46	C 18	B 51	A 31	A 47	A 21
20 x 40 x 150	D 49	C 22	B 51	A 31	A 47	A 21
22 x 40 x 150	E 1	C 27	B 51	A 31	A 47	A 22
25 x 40 x 150	E 7	C 31	B 51	A 31	A 47	A 22
30 x 40 x 150	E 45	D 33	C 7	A 40	B 5	A 25
35 x 40 x 150	F 7	E 9	C 14	A 45	B 8	A 28

Los juegos paso A de 40 y 50 mm. de largo, pueden suministrarse para una profundidad de **175 mm.** En este caso la cadena lleva **38** mallas. Los precios son los mismos

Las barras, guías y piñones sirven para una o mas medidas de cadenas, según tabla.

Debajo de las medidas de la cadena se indica el espesor y la composición de la malla central.

Las barras guías y piñones ya vienen marcados para saber las cadenas que se pueden utilizar con los mismos.

6-7	8	9-11	12-17	18-21	22-25	26-30	32-36	38-42
2,5	3	4	6	12 (3x4)	13,5 (3x4,5)	18 x (3x6)	22,5 (5x4,5)	30 (5x6)

U Utensilegno



CADENAS PASO B - 15,7 mm

Para taladros de **6 a 30 mm.**
Grueso x **30 y 35 Mm** largo
CADENA DE 48 MALLAS

Las cadenas de 18 a 30 mm. tienen 50 mallas, en lugar de 48.

DIMENSIONES	PVP JUEGO COMPLETO	PVP CADENA	PVP BARRA GUIA	PVP PIÑON	PVP COJINETE+TAPAS	PVP J.MALLAS
6 x 30 x 100 o 35 x 100	D 30	C 8	C 1	A 29	A 44	A 16
7 x 30 x 100 o 35 x 100	D 30	C 8	C 1	A 29	A 44	A 16
8 x 30 x 115 o 35 x 115	D 39	C 11	C 1	A 29	A 44	A 16
9 x 30 x 125 o 35 x 125	D 40	C 12	C 1	A 29	A 44	A 17
10 x 30 x 125 o 35 x 125	D 40	C 12	C 1	A 29	A 44	A 17
11 x 30 x 125 o 35 x 125	D 42	C 13	C 1	A 29	A 44	A 17
12 x 30 x 125 o 35 x 125	D 45	C 16	C 1	A 29	A 44	A 17
13 x 30 x 125 o 35 x 125	D 46	C 17	C 1	A 29	A 44	A 18
14 x 30 x 125 o 35 x 125	D 50	C 21	C 1	A 29	A 44	A 18
15 x 30 x 125 o 35 x 125	D 52	C 24	C 1	A 29	A 44	A 18
16 x 30 x 125 o 35 x 125	E 2	C 25	C 1	A 29	A 44	A 18
17 x 30 x 125 o 35 x 125	E 7	C 31	C 1	A 29	A 44	A 19
18 x 30 x 125 o 35 x 125	E 33	D 9	C 5	A 33	A 46	A 23
20 x 30 x 125 o 35 x 125	E 35	D 16	C 5	A 33	A 46	A 23

CADENAS PASO C - 13,7 mm

Para taladros de **6 a 25 mm.** grueso x **20 y 25 mm** largo **CADENAS DE 54 MALLAS**

DIMENSIONES	PVP JUEGO COMPLETO	PVP CADENA	PVP BARRA GUIA	PVP PIÑON	PVP COJINETE+TAPAS	PVP J.MALLAS
6 x 20 x 95 o 25 x 100	E 6	C 28	C 2	A 28	A 45	A 18
7 x 20 x 95 o 25 x 100	E 6	C 28	C 2	A 28	A 45	A 18
8 x 20 x 110 o 25 x 115	E 6	C 28	C 2	A 28	A 45	A 18
9 x 20 x 125 o 25 x 125	E 6	C 28	C 2	A 28	A 45	A 18
10 x 20 x 125 o 25 x 125	E 6	C 28	C 2	A 28	A 45	A 18
11 x 20 x 125 o 25 x 125	E 9	C 32	C 2	A 28	A 45	A 18
12 x 20 x 125 o 25 x 125	E 12	C 36	C 2	A 28	A 45	A 19
13 x 20 x 125 o 25 x 125	E 17	C 39	C 2	A 28	A 45	A 19
14 x 20 x 125 o 25 x 125	E 19	C 42	C 2	A 28	A 45	A 21
15 x 20 x 125 o 25 x 125	E 23	C 46	C 2	A 28	A 45	A 21
16 x 20 x 125 o 25 x 125	E 26	C 50	C 2	A 28	A 45	A 21
17 x 20 x 125 o 25 x 125	E 29	D 2	C 2	A 28	A 45	A 21
18 x 20 x 125 o 25 x 125	E 41	D 31	C 5	A 33	A 48	A 23
20 x 20 x 125 o 25 x 125	E 44	D 39	C 5	A 33	A 48	A 26

Las cadenas de 18 a 25 Mm tienen 56 mallas en lugar de 54

U Utensilegno

DIMENSIONES	PVP JUEGO COMPLETO	PVP JUEGO DOS BARRAS GUIA	PVP DISTANCIADOR
6-6-6 x 40 A	F 1	D 21	A 27
8-8-8 x 40 A	B 52	D 15	A 27
9-8-9 x 40 A	F 1	D 21	A 36
10-8-10 x 40 A	F 1	D 21	A 36
11-8-11 x 40 A	F 4	D 21	A 36
12-8-12 x 40 A	F 7	D 22	A 36
14-8-14 x 40 A	F 9	D 22	A 36
8-8-8 x 50 A	F 17	D 51	A 27
9-8-9 x 50 A	F 19	D 52	A 36
10-8-10 x 50 A	F 19	D 52	A 36
11-8-11 x 50 A	F 21	D 52	A 36
12-8-12 x 50 A	F 24	E 6	A 36
14-8-14 x 50 A	F 25	E 6	A 36
6-6-6 x 30 B o 35 B	F 31	D 42	A 27
8-8-8 x 30 B o 35 B	F 30	D 36	A 27
9-8-9 x 30 B o 35 B	F 31	D 36	A 36
10-8-10 x 30 B o 35 B	F 31	D 36	A 36
11-8-11 x 30 B o 35 B	F 33	D 36	A 36
12-8-12 x 30 B o 35 B	F 38	D 43	A 36
14-8-14 x 30 B o 35 B	F 41	D 43	A 36
6-6-6 x 20 C o 25 C	F 48	D 43	A 27
8-8-8 x 20 C o 25 C	F 45	D 36	A 27
9-8-9 x 20 C o 25 C	F 45	D 36	A 36
10-8-10 x 20 C o 25 C	F 45	D 36	A 36
11-8-11 x 20 C o 25 C	F 48	D 36	A 36
12-8-12 x 20 C o 25 C	G 2	D 42	A 36
14-8-14 x 20 C o 25 C	G 8	D 42	A 36

Los juegos dobles pueden suministrarse con una separación de madera entre taladros distinta a la señalada en la tabla anterior.

Las dos barras guías llevan lubricación.

Se fabrican bajo demanda otras medidas y combinaciones de juegos dobles .

Podemos suministrar cadenas con diferentes número de mallas. En este caso el precio se obtiene multiplicando el número de mallas deseado por el precio de una malla de la medida y paso correspondiente .

Bajo demanda las cadenas pueden tener un tratamiento de CROMO DURO para aumentar la duración del corte . Tiene un aumento en precio de 35 €.

U Utensilegno

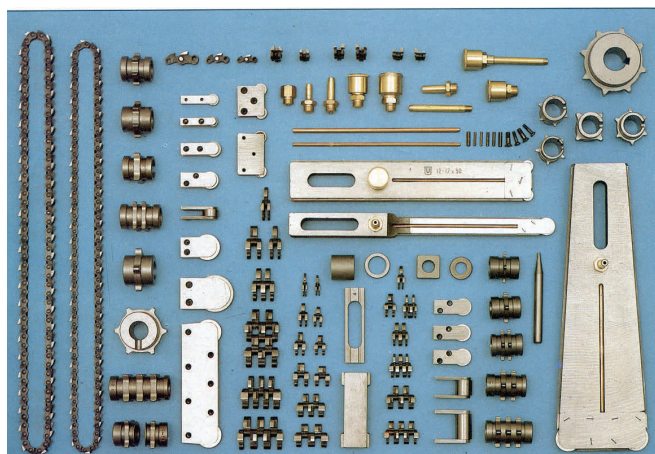

PIEZAS DE RECAMBIO PARA TODOS LOS PASOS	PVP
COJINETE PARA BARRA GUIA TIPO ANTIGUIO (SIN TAPAS)	A 30
TAPA COJINETE PARA BARRAS GUIA TIPO ANTIGUO	A 25
TORNILLO PARA COJINETES	0,50 €
REMACHE	0,50 €
TUBO DE COBRE ENGRASE PARA BARRA GUIA	A 10
RACOR ENGRASE PARA TUBO PLASTICO 1/8 - 4	A 3
RACOR ENGRASE PARA TUBO PLASTICO 1/8 - 7	A 8
ENGRASADORES STAUFFER PARA BARRA GUIA	A 7

REPARACIONES	PVP
AFILAR CADENAS DE PASO A	A 18
AFILAR CADENAS DE PASO B	A 18
AFILAR CADENAS DE PASO C	A 18
CAMBIAR MALLA ROTA O REMACHE	A 33
CAMBIAR COJINETE DE RECAMBIO	A 33



ESTUCHES DE CUCHILLAS OMAS 394 - 396 - 397 COMPUESTO		PVP
1 CABEZAL PORTA CUCHILLAS Z 2 (indicar medidas del cabezal según tabla de repuestos)		
14 PARES DE CUCHILLAS DE ACERO CON UN PERFIL		
1 PIEDRA ASENTAR FILO DE CORTE		
1 LLAVE PARA APRETAR LAS CUCHILLAS		
PRECIO DEL ESTUCHE COMPLETO		E 43

ESTUCHE DE CUCHILLAS OMAS 394 R - 396 R - 397 R COMPUESTO		PVP
13 PARES DE CUCHILLAS DE ACERO CON UN PERFIL		
1 PIEDRA ASENTAR FILO DE CORTE		
1 LLAVE PARA APRETAR LAS CUCHILLAS		
PRECIO DEL ESTUCHE SIN CABEZAL		E 8

REPUESTOS DE CUCHILLAS Y CABEZALES		PVP
CABEZAL REF 394 T Ø 100 Ø 30 Z 2		C 32
CABEZAL REF 394 T Ø 100 Ø 35 Z 2		C 32
CABEZAL REF 394 T Ø 120 Ø 40 Z 2		C 32
CABEZAL REF 394 T Ø 120 Ø 50 Z 2		C 32
CUCHILLA DE REPUESTO RECTA REF 141(por unidad)		A 14
CUCHILLAS DE REPUESTO PERFIL REF 142 A LA 166 C (por unidad)		A 24
PIEDRA PARA ASENTAR FILO DE CORTE		A 15
TORNILLOS DE APRIETE		A 2
LLAVE DE APRIETE CUCHILLAS		A 12

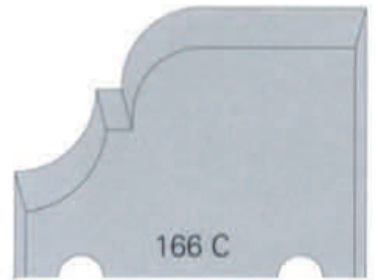
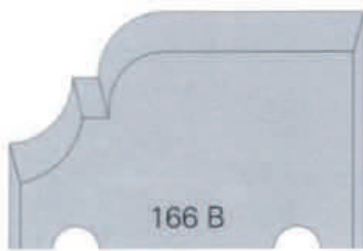
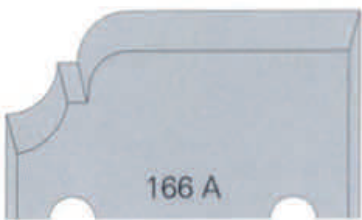
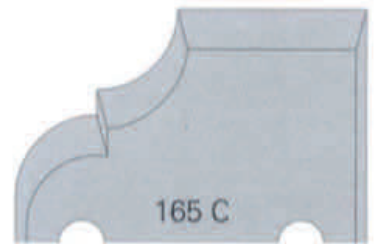
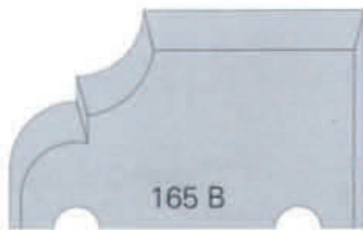
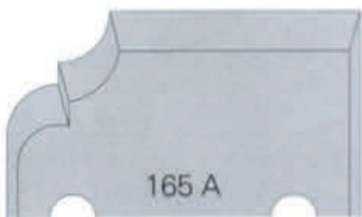
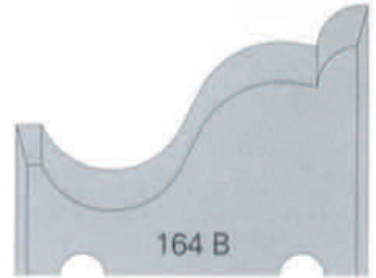
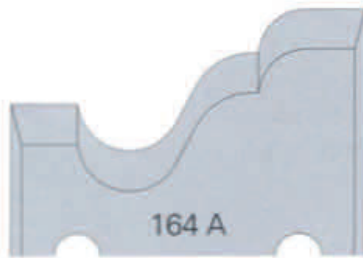
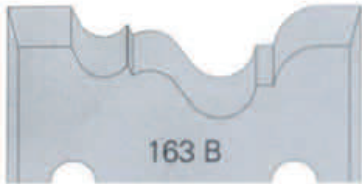
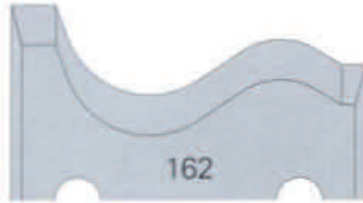
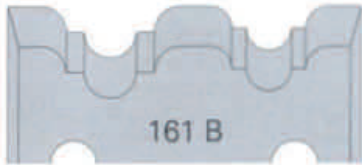
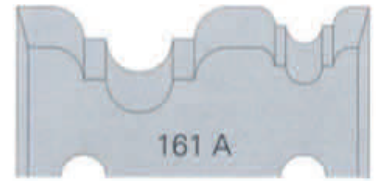

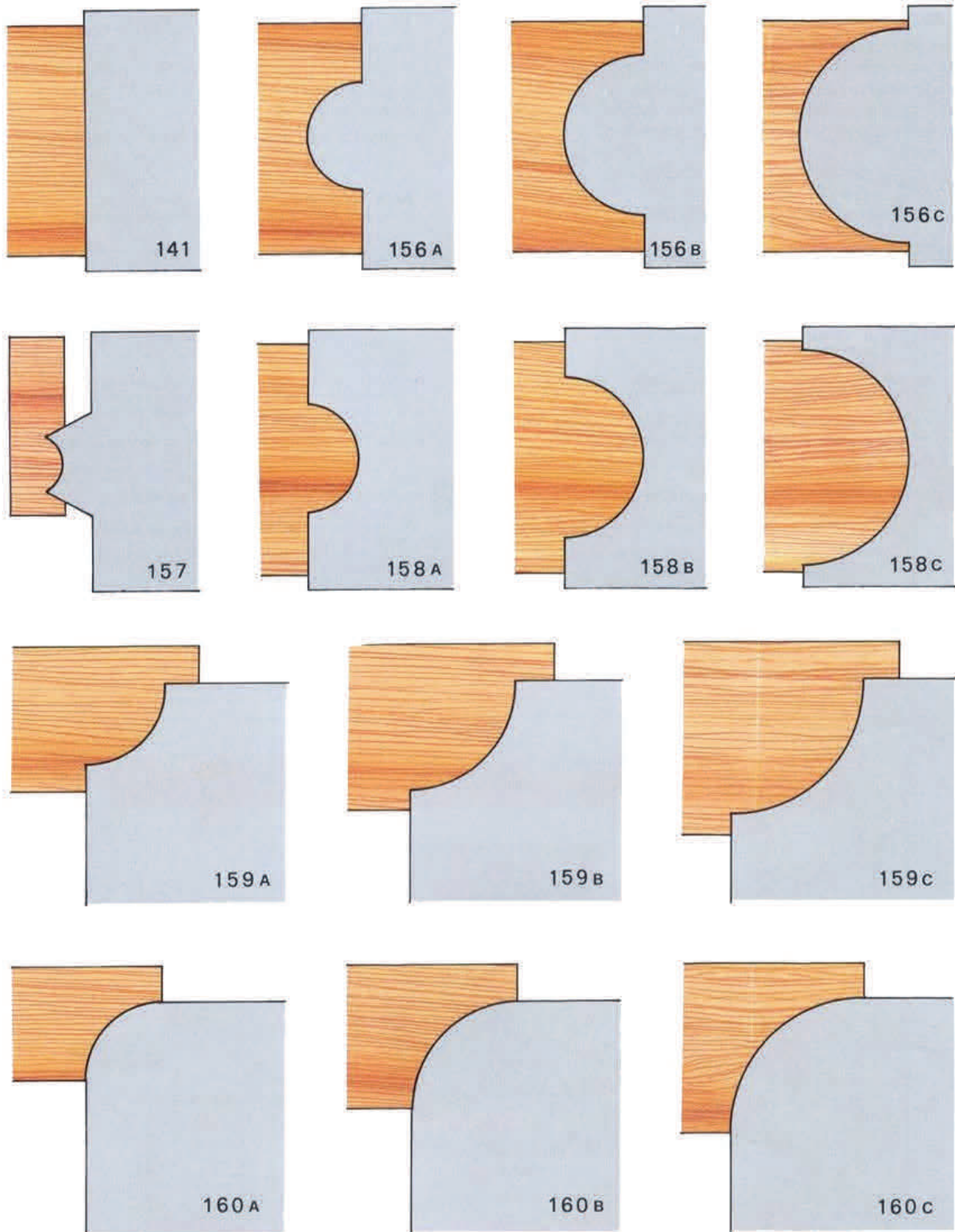

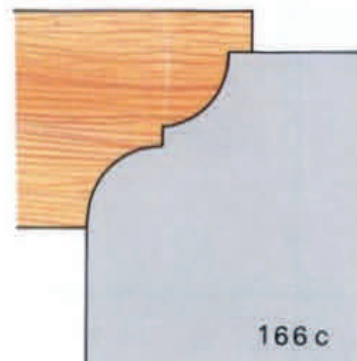
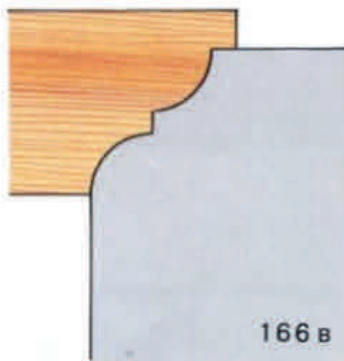
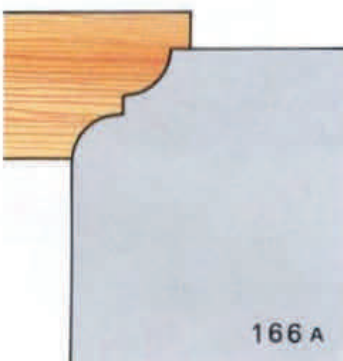
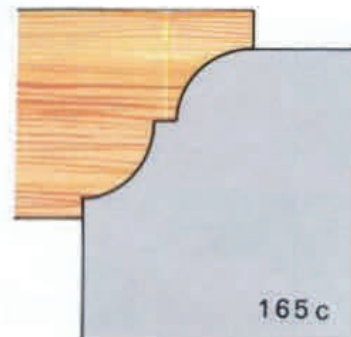
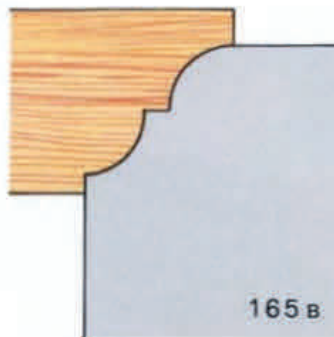
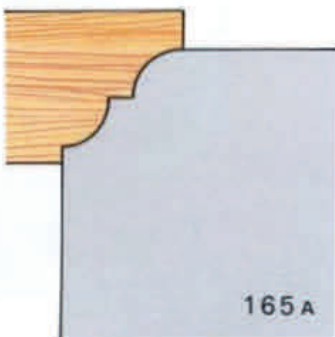
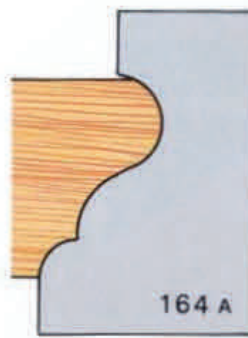
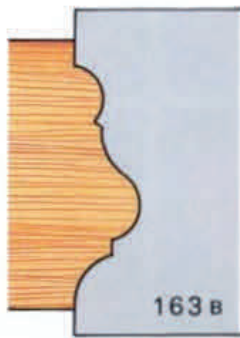
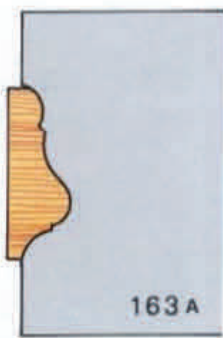
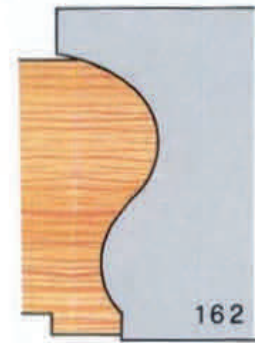
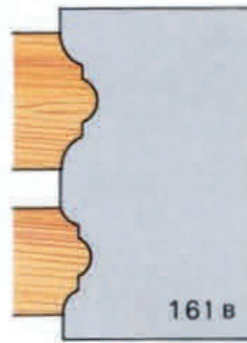
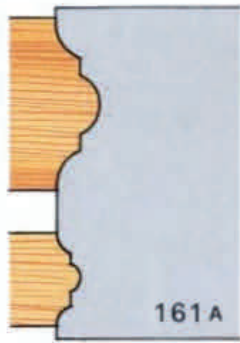
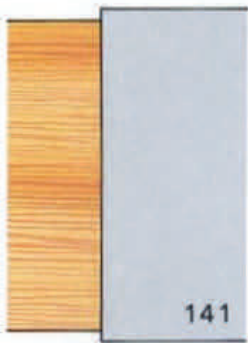

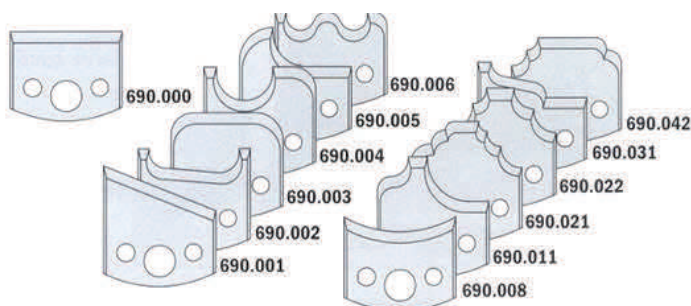
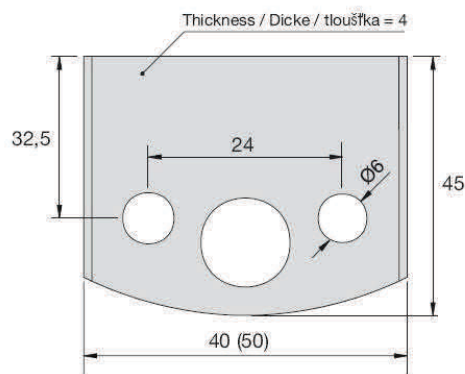

DENOMINACION	REFERENCIA	PVP
Estuche de 13 pares de cuchillas perfiladas Ø 100 Ø 30 z 2 h 40	692,013,02	D 4
Estuche de 13 pares de cuchillas perfiladas Ø 100 Ø 35 z 2 h 40	692,013,03	D 4
Estuche de 13 pares de cuchillas perfiladas Ø 120 Ø 50 z 2 h 40	692,013,04	D 4
Cuchillas incluidas ref. 690000-690001-690014-690015-690016-690017 690029-690052-690089-690098-690099-690100-690106		

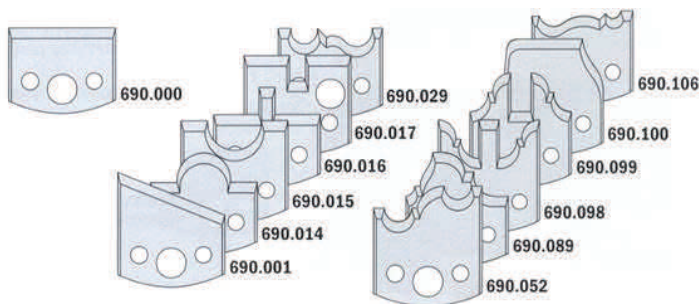

DENOMINACION	REFERENCIA	PVP
Estuche de 13 pares de cuchillas perfiladas Ø 100 Ø 30 z 2 h 40	692,013,06	D 4
Estuche de 13 pares de cuchillas perfiladas Ø 100 Ø 35 z 2 h 40	692,013,07	D 4
Estuche de 13 pares de cuchillas perfiladas Ø 120 Ø 50 z 2 h 40	692,013,08	D 4
Cuchillas incluidas ref. 690000-690001-690002-690003-690004-690005-690006 690008-690011-690021-690022-690031-690042		

Cabezales en cuerpo de aluminio, con pasadores de centraje para la colocación automática de las cuchillas.
Sin contra cuchillas para trabajo con avance mecánico MEC.

Cuchillas estándar validas para acoplar a los cabezales de las siguientes marcas:

Cmt - Bsp - Leaz - Zubiola - Herki etc.

Las cuchillas y las contra cuchillas se venden por pares.

Planos de los diferentes modelos de cuchillas ver paginas 246 a 254.

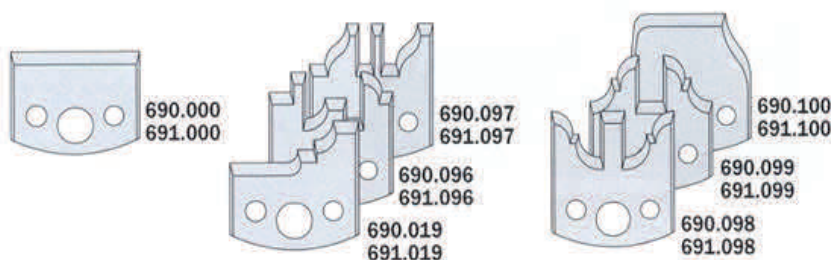
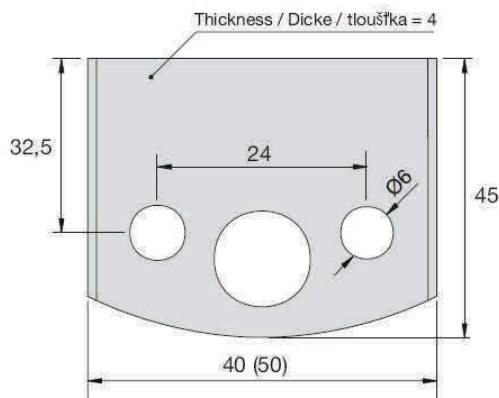

DENOMINACION	REFERENCIA	PVP
Estuche de 13 pares de cuchillas perfiladas Ø 100 Ø 30 z 2 h 40	693,013,01	D 18
Estuche de 13 pares de cuchillas perfiladas Ø 100 Ø 35 z 2 h 40	693,013,01	D 18
Estuche de 13 pares de cuchillas perfiladas Ø 120 Ø 50 z 2 h 40	693,013,03	D 18
Cuchillas incluidas ref. 690000-690019-690096-690097-690098-690099-690100		

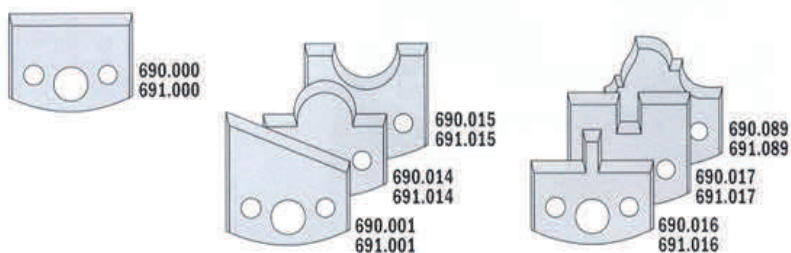

DENOMINACION	REFERENCIA	PVP
Estuche de 13 pares de cuchillas perfiladas Ø 100 Ø 30 z 2 h 40	692,013,06	D 18
Estuche de 13 pares de cuchillas perfiladas Ø 100 Ø 35 z 2 h 40	692,013,07	D 18
Estuche de 13 pares de cuchillas perfiladas Ø 120 Ø 50 z 2 h 40	692,013,08	D 18
Cuchillas incluidas ref. 690000-690001-690,014-690015-690016-690017-690089		

Cabezales en cuerpo de aluminio con pasadores de centraje para la colocación automática de las cuchillas.
Con contra cuchillas para avance manual MAN.

Cuchillas estándar validas para acoplar a los cabezales de las siguientes marcas:

Cmt - Bsp - Le aiz - Zubiola - Herki etc.

Las cuchillas y las contra cuchillas se venden por pares.

Planos de los diferentes modelos de cuchillas ver paginas 246 a 254.



Par de cuchillas **690.000**
Par contracuchillas **691.000**



Par de cuchillas **690.001**
Par contracuchillas **691.001**



Par de cuchillas **690.002**
Par contracuchillas **691.002**



Par de cuchillas **690.003**
Par contracuchillas **691.003**



Par de cuchillas **690.004**
Par contracuchillas **691.004**



Par de cuchillas **690.005**
Par contracuchillas **691.005**



Par de cuchillas **690.006**
Par contracuchillas **691.006**



Par de cuchillas **690.007**
Par contracuchillas **691.007**



Par de cuchillas **690.008**
Par contracuchillas **691.008**



Par de cuchillas **690.009**
Par contracuchillas **691.009**



Par de cuchillas **690.010**
Par contracuchillas **691.010**



Par de cuchillas **690.011**
Par contracuchillas **691.011**



Par de cuchillas **690.012**
Par contracuchillas **691.012**



Par de cuchillas **690.013**
Par contracuchillas **691.013**



Par de cuchillas **690.014**
Par contracuchillas **691.014**



Par de cuchillas **690.015**
Par contracuchillas **691.015**

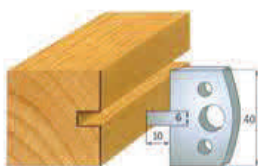

Par de cuchillas **690.016**
Par contracuchillas **691.016**



Par de cuchillas **690.017**
Par contracuchillas **691.017**

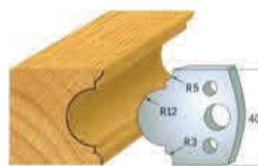

Par de cuchillas **690.018**
Par contracuchillas **691.018**



Par de cuchillas **690.019**
Par contracuchillas **691.019**



Par de cuchillas **690.020**
Par contracuchillas **691.020**

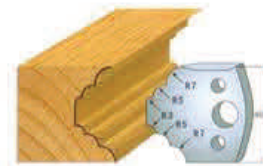

Par de cuchillas **690.021**
Par contracuchillas **691.021**



Par de cuchillas **690.022**
Par contracuchillas **691.022**

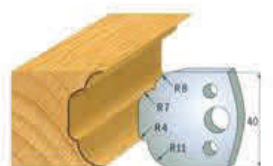

Par de cuchillas **690.023**
Par contracuchillas **691.023**



Par de cuchillas **690.024**
Par contracuchillas **691.024**



Par de cuchillas **690.025**
Par contracuchillas **691.025**



Par de cuchillas **690.026**
Par contracuchillas **691.026**



Par de cuchillas **690.027**
Par contracuchillas **691.027**



Par de cuchillas **690.028**
Par contracuchillas **691.028**

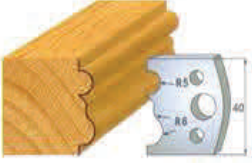

Par de cuchillas **690.029**
Par contracuchillas **691.029**



Par de cuchillas **690.030**
Par contracuchillas **691.030**



Par de cuchillas **690.031**
Par contracuchillas **691.031**



Par de cuchillas **690.032**
Par contracuchillas **691.032**



Par de cuchillas **690.033**
Par contracuchillas **691.033**



Par de cuchillas **690.034**
Par contracuchillas **691.034**



Par de cuchillas **690.035**
Par contracuchillas **691.035**



Par de cuchillas **690.036**
Par contracuchillas **691.036**



Par de cuchillas **690.037**
Par contracuchillas **691.037**



Par de cuchillas **690.038**
Par contracuchillas **691.038**



Par de cuchillas **690.039**
Par contracuchillas **691.039**



Par de cuchillas **690.040**
Par contracuchillas **691.040**

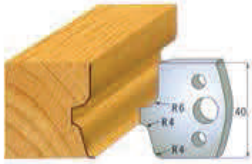

Par de cuchillas **690.041**
Par contracuchillas **691.041**



Par de cuchillas **690.042**
Par contracuchillas **691.042**



Par de cuchillas **690.043**
Par contracuchillas **691.043**



Par de cuchillas **690.044**
Par contracuchillas **691.044**



Par de cuchillas **690.045**
Par contracuchillas **691.045**



Par de cuchillas **690.046**
Par contracuchillas **691.046**



Par de cuchillas **690.047**
Par contracuchillas **691.047**



Par de cuchillas **690.048**
Par contracuchillas **691.048**



Par de cuchillas **690.049**
Par contracuchillas **691.049**



Par de cuchillas **690.050**
Par contracuchillas **691.050**



Par de cuchillas **690.051**
Par contracuchillas **691.051**



Par de cuchillas **690.052**
Par contracuchillas **691.052**



Par de cuchillas **690.053**
Par contracuchillas **691.053**



Par de cuchillas **690.054**
Par contracuchillas **691.054**



Par de cuchillas **690.055**
Par contracuchillas **691.055**



Par de cuchillas **690.056**
Par contracuchillas **691.056**



Par de cuchillas **690.057**
Par contracuchillas **691.057**



Par de cuchillas **690.058**
Par contracuchillas **691.058**



Par de cuchillas **690.059**
Par contracuchillas **691.059**



Par de cuchillas **690.060**
Par contracuchillas **691.060**



Par de cuchillas **690.061**
Par contracuchillas **691.061**



Par de cuchillas **690.062**
Par contracuchillas **691.062**



Par de cuchillas **690.063**
Par contracuchillas **691.063**



Par de cuchillas **690.064**
Par contracuchillas **691.064**



Par de cuchillas **690.065**
Par contracuchillas **691.065**



Par de cuchillas **690.066**
Par contracuchillas **691.066**



Par de cuchillas **690.067**
Par contracuchillas **691.067**



Par de cuchillas **690.068**
Par contracuchillas **691.068**



Par de cuchillas **690.069**
Par contracuchillas **691.069**



Par de cuchillas **690.070**
Par contracuchillas **691.070**

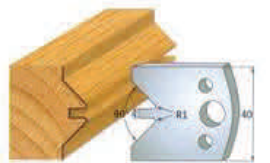

Par de cuchillas **690.071**
Par contracuchillas **691.071**



Par de cuchillas **690.072**
Par contracuchillas **691.072**



Par de cuchillas **690.073**
Par contracuchillas **691.073**



Par de cuchillas **690.074**
Par contracuchillas **691.074**



Par de cuchillas **690.075**
Par contracuchillas **691.075**



Par de cuchillas **690.076**
Par contracuchillas **691.076**



Par de cuchillas **690.077**
Par contracuchillas **691.077**



Par de cuchillas **690.078**
Par contracuchillas **691.078**



Par de cuchillas **690.079**
Par contracuchillas **691.079**



Par de cuchillas **690.080**
Par contracuchillas **691.080**



Par de cuchillas **690.081**
Par contracuchillas **691.081**



Par de cuchillas **690.082**
Par contracuchillas **691.082**



Par de cuchillas **690.083**
Par contracuchillas **691.083**

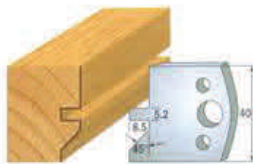

Par de cuchillas **690.084**
Par contracuchillas **691.084**



Par de cuchillas **690.085**
Par contracuchillas **691.085**



Par de cuchillas **690.086**
Par contracuchillas **691.086**



Par de cuchillas **690.087**
Par contracuchillas **691.087**

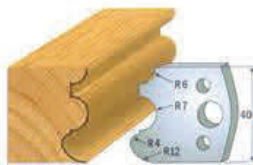

Par de cuchillas **690.088**
Par contracuchillas **691.088**



Par de cuchillas **690.089**
Par contracuchillas **691.089**



Par de cuchillas **690.090**
Par contracuchillas **691.090**



Par de cuchillas **690.091**
Par contracuchillas **691.091**

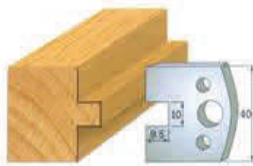

Par de cuchillas **690.092**
Par contracuchillas **691.092**



Par de cuchillas **690.093**
Par contracuchillas **691.093**

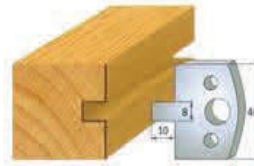

Par de cuchillas **690.094**
Par contracuchillas **691.094**



Par de cuchillas **690.095**
Par contracuchillas **691.095**



Par de cuchillas **690.096**
Par contracuchillas **691.096**

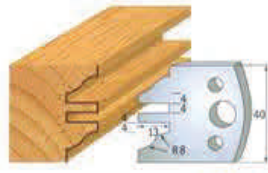

Par de cuchillas **690.097**
Par contracuchillas **691.097**



Par de cuchillas **690.098**
Par contracuchillas **691.098**



Par de cuchillas **690.099**
Par contracuchillas **691.099**



Par de cuchillas **690.100**
Par contracuchillas **691.100**



Par de cuchillas **690.101**
Par contracuchillas **691.101**

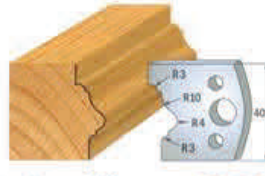

Par de cuchillas **690.102**
Par contracuchillas **691.102**



Par de cuchillas **690.103**
Par contracuchillas **691.103**

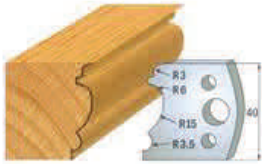

Par de cuchillas **690.104**
Par contracuchillas **691.104**



Par de cuchillas **690.105**
Par contracuchillas **691.105**



Par de cuchillas **690.106**
Par contracuchillas **691.106**



Par de cuchillas **690.107**
Par contracuchillas **691.107**



Par de cuchillas **690.108**
Par contracuchillas **691.108**



Par de cuchillas **690.109**
Par contracuchillas **691.109**



Par de cuchillas **690.110**
Par contracuchillas **691.110**



Par de cuchillas **690.111**
Par contracuchillas **691.111**



Par de cuchillas **690.112**
Par contracuchillas **691.112**



Par de cuchillas **690.113**
Par contracuchillas **691.113**



Par de cuchillas **690.114**
Par contracuchillas **691.114**



Par de cuchillas **690.115**
Par contracuchillas **691.115**



Par de cuchillas **690.116**
Par contracuchillas **691.116**



Par de cuchillas **690.117**
Par contracuchillas **691.117**



Par de cuchillas **690.118**
Par contracuchillas **691.118**



Par de cuchillas **690.119**
Par contracuchillas **691.119**



Par de cuchillas **690.120**
Par contracuchillas **691.120**



Par de cuchillas **690.121**
Par contracuchillas **691.121**



Par de cuchillas **690.122**
Par contracuchillas **691.122**



Par de cuchillas **690.123**
Par contracuchillas **691.123**



Par de cuchillas **690.124**
Par contracuchillas **691.124**



Par de cuchillas **690.125**
Par contracuchillas **691.125**



Par de cuchillas **690.126**
Par contracuchillas **691.126**



Par de cuchillas **690.127**
Par contracuchillas **691.127**



Par de cuchillas **690.128**
Par contracuchillas **691.128**



Par de cuchillas **690.129**
Par contracuchillas **691.129**

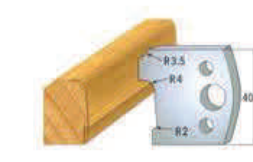

Par de cuchillas **690.130**
Par contracuchillas **691.130**



Par de cuchillas **690.131**
Par contracuchillas **691.131**



Par de cuchillas **690.132**
Par contracuchillas **691.132**



Par de cuchillas **690.133**
Par contracuchillas **691.133**

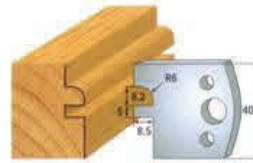

Par de cuchillas **690.134**
Par contracuchillas **691.134**



Par de cuchillas **690.135**
Par contracuchillas **691.135**

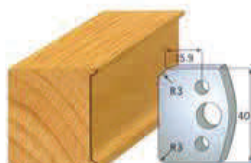

Par de cuchillas **690.170**
Par contracuchillas **691.170**



Par de cuchillas **690.171**
Par contracuchillas **691.171**



Par de cuchillas **690.172**
Par contracuchillas **691.172**



Par de cuchillas **690.173**
Par contracuchillas **691.173**



Par de cuchillas **690.174**
Par contracuchillas **691.174**



Par de cuchillas **690.175**
Par contracuchillas **691.175**



Par de cuchillas **690.176**
Par contracuchillas **691.176**



Par de cuchillas **690.177**
Par contracuchillas **691.177**

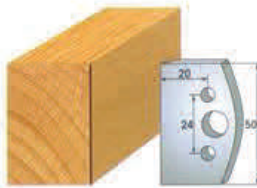

Par de cuchillas **690.500**
Par contracuchillas **691.500**

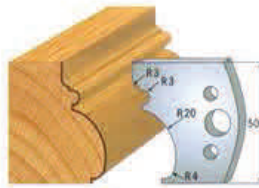

Par de cuchillas **690.501**
Par contracuchillas **691.501**



Par de cuchillas **690.502**
Par contracuchillas **691.502**

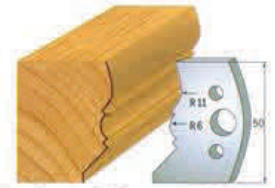

Par de cuchillas **690.503**
Par contracuchillas **691.503**

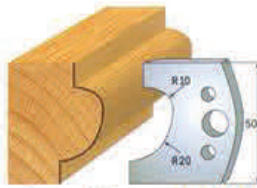

Par de cuchillas **690.504**
Par contracuchillas **691.504**

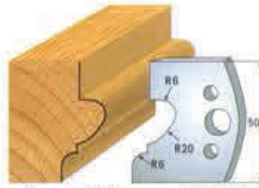

Par de cuchillas **690.505**
Par contracuchillas **691.505**

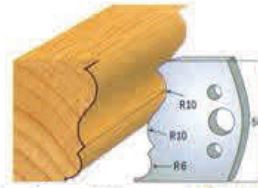

Par de cuchillas **690.506**
Par contracuchillas **691.506**

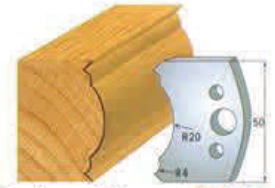

Par de cuchillas **690.507**
Par contracuchillas **691.507**

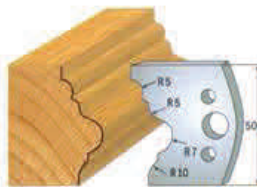

Par de cuchillas **690.508**
Par contracuchillas **691.508**

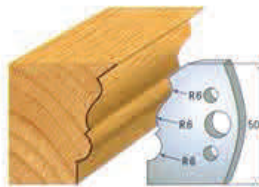

Par de cuchillas **690.509**
Par contracuchillas **691.509**

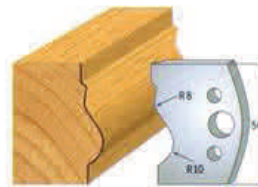

Par de cuchillas **690.510**
Par contracuchillas **691.510**



Par de cuchillas **690.511**
Par contracuchillas **691.511**



Par de cuchillas **690.512**
Par contracuchillas **691.512**

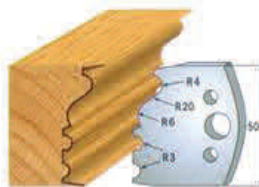

Par de cuchillas **690.513**
Par contracuchillas **691.513**



Par de cuchillas **690.514**
Par contracuchillas **691.514**

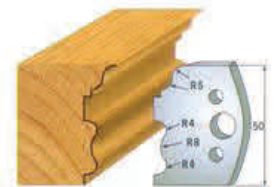

Par de cuchillas **690.515**
Par contracuchillas **691.515**



Par de cuchillas **690.516**
Par contracuchillas **691.516**



Par de cuchillas **690.517**
Par contracuchillas **691.517**



Par de cuchillas **690.518**
Par contracuchillas **691.518**

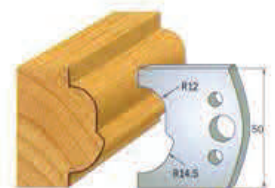

Par de cuchillas **690.519**
Par contracuchillas **691.519**



Par de cuchillas **690.520**
Par contracuchillas **691.520**



Par de cuchillas **690.522**
Par contracuchillas **691.522**



Par de cuchillas **690.523**
Par contracuchillas **691.523**



Par de cuchillas **690.524**
Par contracuchillas **691.524**



Par de cuchillas: 690.541
Par contracuchillas: 691.541

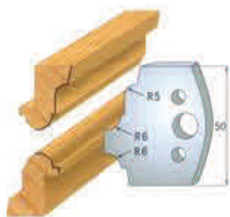

Par de cuchillas: 690.542
Par contracuchillas: 691.542

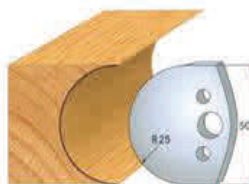

Par de cuchillas: 690.543
Par contracuchillas: 691.543



Par de cuchillas: 690.544
Par contracuchillas: 691.544

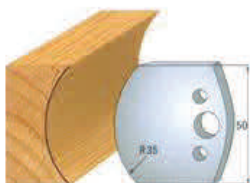

Par de cuchillas: 690.545
Par contracuchillas: 691.545

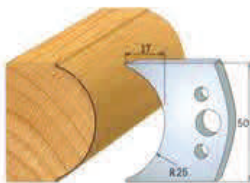

Par de cuchillas: 690.546
Par contracuchillas: 691.546



Par de cuchillas: 690.547
Par contracuchillas: 691.547



Par de cuchillas: 690.548
Par contracuchillas: 691.548

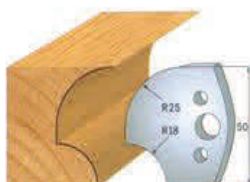

Par de cuchillas: 690.549
Par contracuchillas: 691.549

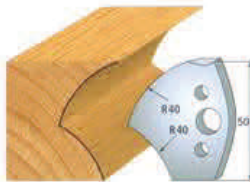

Par de cuchillas: 690.550
Par contracuchillas: 691.550



Par de cuchillas: 690.551
Par contracuchillas: 691.551



Par de cuchillas: 690.552
Par contracuchillas: 691.552



Par de cuchillas: 690.553
Par contracuchillas: 691.553

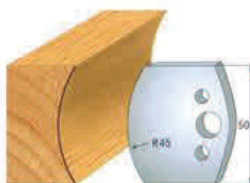

Par de cuchillas: 690.554
Par contracuchillas: 691.554



Par de cuchillas: 690.555
Par contracuchillas: 691.555



Par de cuchillas: 690.556
Par contracuchillas: 691.556



Par de cuchillas: 690.557
Par contracuchillas: 691.557



Par de cuchillas: 690.558
Par contracuchillas: 691.558



Par de cuchillas: 690.559
Par contracuchillas: 691.559



Par de cuchillas: 690.560
Par contracuchillas: 691.560



Par de cuchillas: 690.561
Par contracuchillas: 691.561



Par de cuchillas: 690.562
Par contracuchillas: 691.562



Par de cuchillas: 690.563
Par contracuchillas: 691.563



Par de cuchillas: 690.564
Par contracuchillas: 691.564



Par de cuchillas **690.565**
Par contracuchillas **691.565**



Par de cuchillas **690.566**
Par contracuchillas **691.566**



Par de cuchillas **690.567**
Par contracuchillas **691.567**

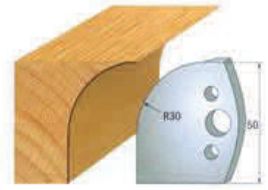

Par de cuchillas **690.568**
Par contracuchillas **691.568**



Par de cuchillas **690.569**
Par contracuchillas **691.569**

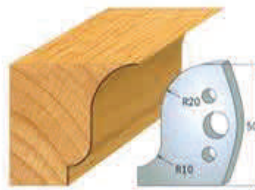

Par de cuchillas **690.570**
Par contracuchillas **691.570**



Par de cuchillas **690.571**
Par contracuchillas **691.571**



Par de cuchillas **690.572**
Par contracuchillas **691.572**



Par de cuchillas **690.573**
Par contracuchillas **691.573**



Par de cuchillas **690.574**
Par contracuchillas **691.574**



Par de cuchillas **690.575**
Par contracuchillas **691.575**

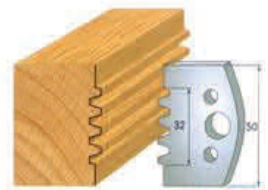

Par de cuchillas **690.576**
Par contracuchillas **691.576**



Par de cuchillas **690.577**
Par contracuchillas **691.577**



Par de cuchillas **690.578**
Par contracuchillas **691.578**



Par de cuchillas **690.579**
Par contracuchillas **691.579**

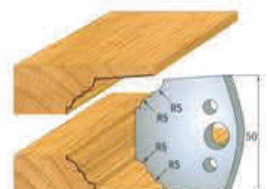

Par de cuchillas **690.580**
Par contracuchillas **691.580**

DENOMINACION	REFERENCIA	VVP
Par de cuchillas áceros semirápido sr perfil de 40 mm de ancho	de 690,000 a 690,177	A 22
par de cuchillas áceros semirápido sr perfil de 50 mm de ancho	de 690,500 a 690,580	A 31
Par de contra cuchillas áceros perfil de 40 mm de ancho	de 691,000 a 691,177	A 20
Par de contra cuchillas áceros perfil de 50 mm de ancho	de 691,500 a 691,580	A 28

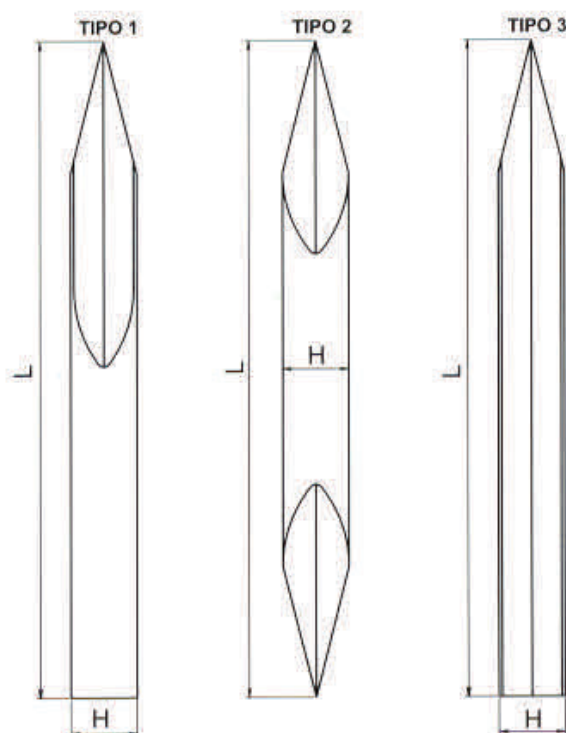

ACERO RAPIDO HSS

H x H x L	FORMA	REFERENCIA	PVP
16 x 16 x 150	1(1 Punta)	0081501601615001	B 10
20 x 20 x 200	1(1 Punta)	0081502002020001	B 24
16 x 16 x 150	2 (2 Puntas)	0081501601620002	B 21
20 x 20 x 200	2 (2 Puntas)	0081502002020002	B 40
16 x 16 x 150	3 (Ranura)	0081501601615003	B 18
20 x 20 x 200	3 (Ranura)	0081502002020003	B 34

METAL DURO

H x H x L	FORMA	REFERENCIA	PVP
16 x 16 x 150	1 (1 Punta)	0091501601615001	B 38
20 x 20 x 200	1 (1 Punta)	0091502002020001	B 42

TANTUN

H x H x L	FORMA	REFERENCIA	PVP
18 x 18 x 180	3 (Ranura)	0101501801818003	C 20
20 x 20 x 180	3 (ranura)	0101502002018003	C 24

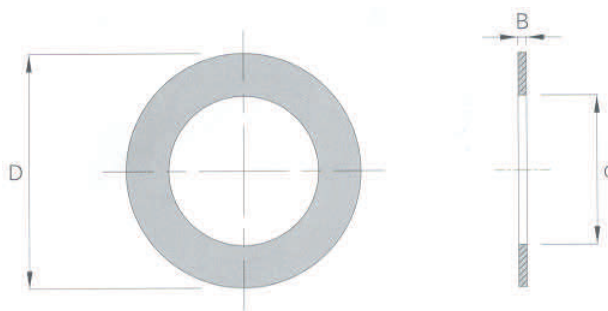

D	d	E	REFERENCIA	PVP
20	18	2,0	0171002001800200	A 7
20	16	2,0	0171002001600200	A 7
20	13	2,0	0171002001302000	A 7
20	12	2,0	0171002001200200	A 7
22	20	2,0	0171002202000200	A 9
25	20	2,0	0171002502000200	A 7
30	16	2,0	0171003001600200	A 9
30	18	2,0	0171003001800200	A 9
30	20	2,0	0171003002000200	A 7
30	22	2,0	0171003002200200	A 7
30	25	2,0	0171003002500200	A 9
30	25,5	2,0	0171003025500200	A 9
30	27	2,0	0171003002700200	A 9
30	28	2,0	0171003002800200	A 9
32	16	2,0	0171003201600200	A 7
32	20	2,0	0171003202000200	A 7
32	25	2,0	0171003202500200	A 7
32	30	2,0	0171003203000200	A 9
32	30	3,0	0171003203000300	A 9
35	16	2,0	0171003501600200	A 9
35	18	2,0	0171003501800200	A 9
35	20	2,0	0171003502000200	A 9
35	22	2,0	0171003502200200	A 9
35	25	2,0	0171003502500200	A 9
35	30	2,0	0171003503000200	A 9
35	32	2,0	0171003503200220	A 9
38	30	2,0	0171003803000200	A 9
40	20	2,0	0171004002000200	A 9
40	25	2,0	0171004002500200	A 9
40	30	2,0	0171004003000200	A 9
40	32	2,0	0171004003200200	A 9
40	35	2,0	0171004003500200	A 9
45	35	2,0	0171004503500200	A 11
45	40	2,0	0171004504000200	A 11
50	30	2,0	0171005003000200	A 11
50	35	2,0	0171005003500200	A 11
50	40	2,0	0171005004000200	A 11

Para otras medidas comprendidas entre los diámetros exteriores de Ø 20 a Ø 50 con espesor de 2.0 mm:

PRECIO POR UNIDAD A 21

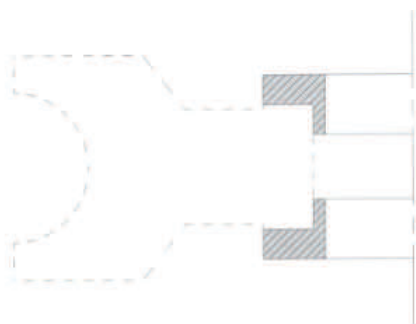
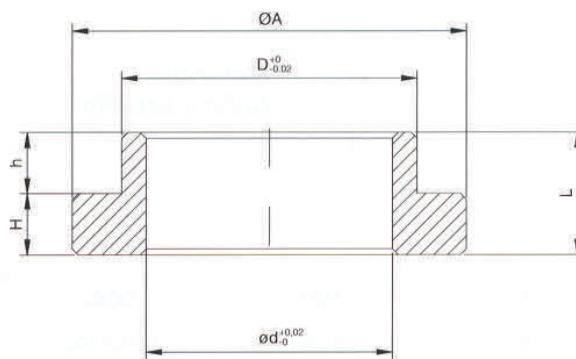

JUEGO DE DOS PIEZAS

d	D	Ø A	H	h	L	REFERENCIA	PVP
30	35	55	7,5	7,5	15	0171103003501500	A 32
30	40	60	7,5	7,5	15	0171103004001500	A 32
30	50	70	7,5	7,5	15	0171103005001500	A 34
35	40	60	7,5	7,5	15	0171103504001500	A 34

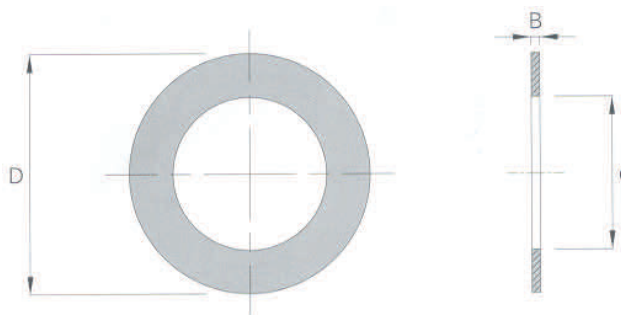

D	d	H	REFERENCIA	PVP
40	30	10	0171204003001000	A 25
40	30	15	0171204003001500	A 25
40	30	20	0171204003002000	A 27
40	30	30	0171204003003000	A 27
40	30	40	0171204003004000	A 31
40	30	50	0171204003005000	A 33
40	30	60	0171204003006000	A 35
40	30	70	0171204003007000	A 37
40	35	10	0171204003501000	A 26
40	35	15	0171204003501500	A 26
40	35	20	0171204003502000	A 19
40	35	30	0171204003503000	A 30
40	35	40	0171204003504000	A 32
40	35	50	0171204003505000	A 34
40	35	60	0171204003506000	A 36
40	35	70	0171204003507000	A 38

D	d	H	REFERENCIA	PVP
50	35	10	0171205003501000	A 27
50	35	15	0171205003501500	A 29
50	35	20	0171205003502000	A 29
50	35	30	0171205003503000	A 31
50	35	40	0171205003504000	A 33
50	35	50	0171205003505000	A 35
50	35	60	0171205003506000	A 37
50	35	70	0171205003507000	A 39
50	40	10	0171205004001000	A 27
50	40	15	0171205004001500	A 27
50	40	20	0171205004002000	A 29
50	40	30	0171205004003000	A 31
50	40	40	0171205004004000	A 33
50	40	50	0171205004005000	A 35
50	40	60	0171205004006000	A 37
50	40	70	0171205004007000	A 39

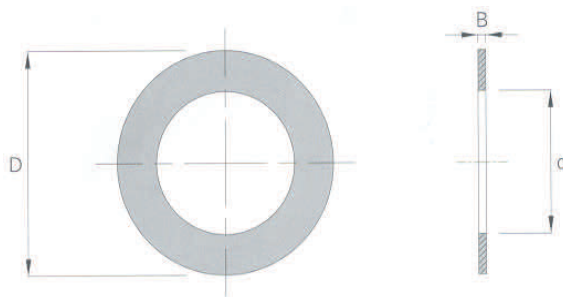

d	D	H	REFERENCIA	PVP
30	50	2	0171303005000200	A 8
30	50	3	0171303005000300	A 8
30	50	4	0171303005000400	A 9
30	50	5	0171303005000500	A 9
30	50	6	0171303005000600	A 10
30	50	7	0171303005000700	A 10
30	50	8	0171303005000800	A 11
30	50	9	0171303005000900	A 12
30	50	10	0171303005001000	A 13
30	50	11	0171303005001100	A 13
30	50	12	0171303005001200	A 14
30	50	14	0171303005001400	A 14
30	50	15	0171303005001500	A 14
30	50	16	0171303005001600	A 16
30	50	18	0171303005001800	A 16
30	50	20	0171303005002000	A 17
30	50	25	0171303005002500	A 20
30	50	30	0171303005003000	A 21
30	50	40	0171303005004000	A 22
30	50	50	0171303005005000	A 24

d	D	H	REFERENCIA	PVP
32	50	2	0171303205000200	A 13
32	50	3	0171303205000300	A 13
32	50	4	0171303205000400	A 15
32	50	5	0171303205000500	A 15
32	50	6	0171303205000600	A 16
32	50	7	0171303205000700	A 16
32	50	8	0171303205000800	A 17
32	50	9	0171303205000900	A 17
32	50	10	0171303205001000	A 18
32	50	11	0171303205001100	A 18
32	50	12	0171303205001200	A 19
32	50	14	0171303205001400	A 20
32	50	15	0171303205001500	A 20
32	50	16	0171303205001600	A 21
32	50	18	0171303205001800	A 21
32	50	20	0171303205002000	A 22
32	50	25	0171303205002500	A 23
32	50	30	0171303205003000	A 24
32	50	40	0171303205004000	A 27
32	50	50	0171303205005000	A 30

D	d	H	REFERENCIA	PVP
40	60	2	0171304006000200	A 8
40	60	3	0171304006000300	A 9
40	60	4	0171304006000400	A 9
40	60	5	0171304006000500	A 10
40	60	6	0171304006000600	A 11
40	60	7	0171304006000700	A 11
40	60	8	0171304006000800	A 12
40	60	9	0171304006000900	A 12
40	60	10	0171304006001000	A 13
40	60	11	0171304006001100	A 13
40	60	12	0171304006001200	A 14
40	60	14	0171304006001400	A 14
40	60	15	0171304006001500	A 15
40	60	16	0171304006001600	A 17
40	60	18	0171304006001800	A 17
40	60	20	0171304006002000	A 19
40	60	25	0171304006002500	A 20
40	60	30	0171304006003000	A 22
40	60	40	0171304006004000	A 24
40	60	50	0171304006005000	A 27

d	D	H	REFERENCIA	PVP
50	70	2	0171305007000200	A 8
50	70	3	0171305007000300	A 9
50	70	4	0171305007000400	A 10
50	70	5	0171305007000500	A 10
50	70	6	0171305007000600	A 12
50	70	7	0171305007000700	A 12
50	70	8	0171305007000800	A 12
50	70	9	0171305007000900	A 13
50	70	10	0171305007001000	A 14
50	70	11	0171305007001100	A 14
50	70	12	0171305007001200	A 15
50	70	14	0171305007001400	A 16
50	70	15	0171305007001500	A 16
50	70	16	0171305007001600	A 18
50	70	18	0171305007001800	A 19
50	70	20	0171305007002000	A 19
50	70	25	0171305007002500	A 21
50	70	30	0171305007003000	A 23
50	70	40	0171305007004000	A 25
50	70	50	0171305007005000	A 28



Juego de anillos separadores para el relleno de ejes de máquinas. Compuesto por 21 anillos de las siguientes medidas:

2-3-4-5-6-7-8-9-10-11-12-14-15-16-18-20-25 - 30-40 y 50 mm

d	D	REFERENCIA	PVP
30	50	0171303005010000	C 25
32	50	0171303205010000	C 42
40	60	0171304006010000	C 22
50	70	0171305007010000	C 27

Juego de anillos decimales para regular la separación de herramientas.

Cada juego lleva dos piezas de cada medida de las indicadas en la columna COMPOSICIÓN de la tabla que se muestra a continuación.

d	D	COMPOSICION	REFERENCIA	PVP
20	50	0,1-0,2-0,3-0,5-1,0	0171302005010000	A 15
22	50	0,1-0,2-0,3-0,5-1,0	0171302205010000	A 15
27	50	0,1-0,2-0,3-0,5-1,0	0171302705010000	A 21
30	50	0,1-0,2-0,3-0,5-1,0-2,0-3,0	0171303005010000	A 17
32	50	0,1-0,2-0,3-0,5-1,0-2,0-3,0	0171303205010000	A 23
35	55	0,1-0,2-0,3-0,5-1,0-2,0-3,0	0171303505510000	A 17
40	60	0,1-0,2-0,3-0,5-1,0-2,0-3,0	0171304006010000	A 21
50	70	0,1-0,2-0,3-0,5-1,0-2,0-3,0	0171305007010000	A 21
60	80	0,1-0,2-0,3-0,5-1,0-2,0-3,0	0171306008010000	A 26
65	85	0,1-0,2-0,3-0,5	0171306508510000	A 26

JUEGO DE 2 PLATOS EN ACERO

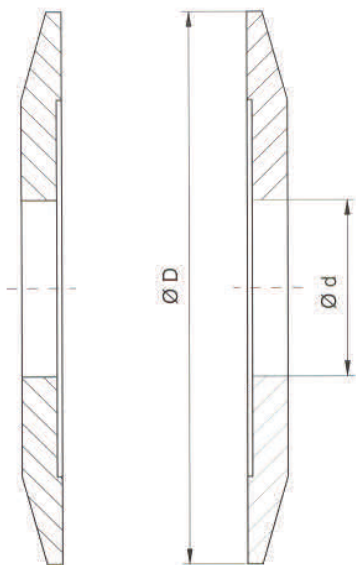

d	D	PARA DISCO Ø	REFERENCIA	PVP
80	30	Ø 250	0171408003010000	B 2
80	35	Ø 250	0171408003510000	B 2
100	30	Ø 300	0171410003010000	B 2
100	35	Ø 300	0171410003510000	B 2
100	40	Ø 300	0171410004010000	B 2
100	50	Ø 300	0171410005010000	B 2
125	30	Ø 350	0171412503010000	B 10
125	35	Ø 350	0171412503510000	B 10
125	40	Ø 350	0171412504010000	B 10
125	50	Ø 350	0171412505010000	B 10

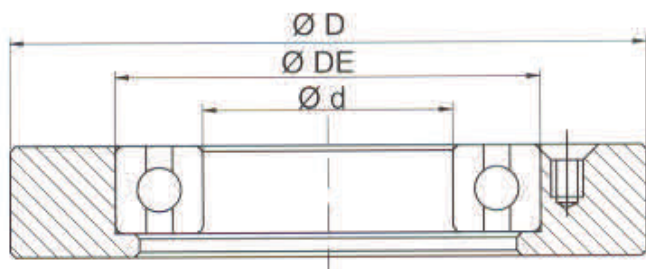

DENOMINACION	REFERENCIA	PVP
RODAMIENTO SUELTO Ø 80 Ø 50	0181008005001400	A 52
CASQUILLO Ø 90	0171509005001400	A 42
CASQUILLO Ø 100	0171510005001400	A 44
CASQUILLO Ø 110	0171511005001400	A 50
CASQUILLO Ø 120	0171512005001400	A 50
CASQUILLO Ø 125	0171512505001400	A 50
CASQUILLO Ø 140	0171514005001400	A 52
CONJUNTO COMPLETO 6 CASQUILLOS + RODAMIENTO	0171510005010000	D 14

PARA OTRAS MEDIDAS DE RODAMIENTO Y CASQUILLO CONSULTAR PRECIO

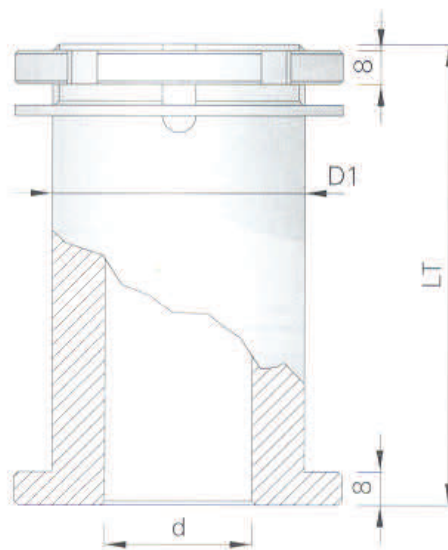

MANGUITO PORTA HERRAMIENTAS PARA EL MONTAJE DE GRUPOS DE FRESAS ROSCA A DERECHAS

d	D	D1	L	REFERENCIA	PVP
30	50	70	75	0171603005007500	B 26
30	50	70	95	0171603005009500	B 26
30	50	70	120	0171603005012000	B 26
35	50	70	60	0171603505006000	B 26
35	50	70	95	0171603505009500	B 26
35	50	70	120	0171603505012000	B 26

d	D	D1	L	REFERENCIA	PVP
40	60	80	90	0171604006009000	B 26
40	60	80	110	0171604006011000	B 26
40	60	80	140	0171604006014000	B 26
50	60	80	60	0171605006006000	B 26
50	60	80	80	0171605006008000	B 26
50	60	80	100	0171605060100000	B 26

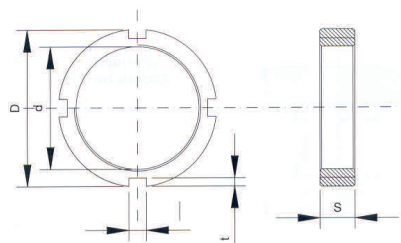

D	L	REFERENCIA	PVP
30 - 32	136	0191003003213600	A 21
34 - 36	170	0191003403617000	A 21
40 - 42	170	0191004004217000	A 21
45 - 50	205	0191004505020500	A 23

ROSCA	S	REFERENCIA	PVP
M 30	6	0191103004000600	A 13
M 32	6	0191103204200600	A 19
M 35	6	0191103504500600	A 13
M 40	8	0191104005000800	A 13
M 50	8	0191105007000800	A 19

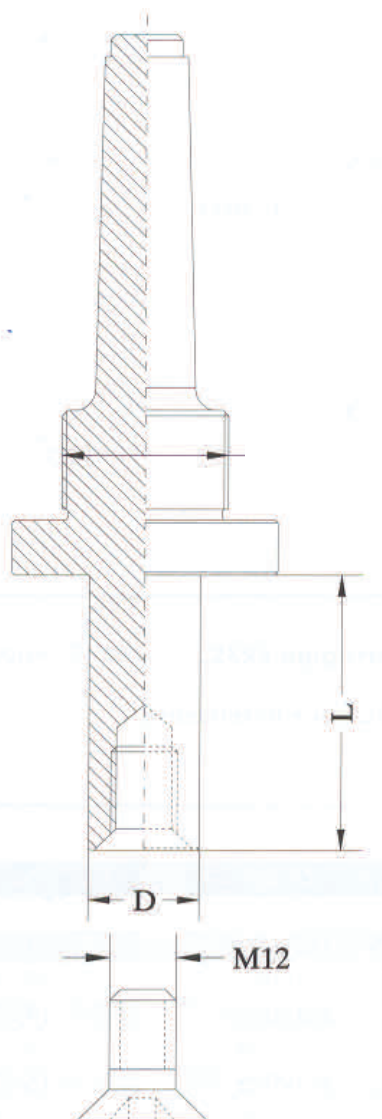
CONO MORSE Nº 2 ROSCA DE Ø 20 x 14

D	L	TIPO CONO	REFERENCIA	PVP
20	30	CM2 Ø 20 x 14	0171602003000210	C 27
20	60	CM2 Ø 20 x 14	0171602006000210	C 30
20	80	CM2 Ø 20 x 14	0171602008000210	C 32
25	30	CM2 Ø 20 x 14	0171602503000210	C 27
25	60	CM2 Ø 20 x 14	0171602506000210	C 30
25	80	CM2 Ø 20 x 14	0171602508000210	C 32
30	30	CM2 Ø 20 x 14	0171603003000210	C 30
30	60	CM2 Ø 20 x 14	0171603006000210	C 32
30	80	CM2 Ø 20 x 14	0171603008000210	C 35
40	60	CM2 Ø 20 x 14	0171604006000210	C 35
50	60	CM2 Ø 20 x 14	0171605006000210	C 37

CONO MORSE Nº 3 ROSCA DE Ø 30 x 1.5

D	L	TIPO CONO	REFERENCIA	PVP
20	30	CM2 Ø 30 x 1,5	0171602003000211	C 27
20	60	CM2 Ø 30 x 1,5	0171602006000211	C 30
20	80	CM2 Ø 30 x 1,5	0171602008000211	C 32
25	30	CM2 Ø 30 x 1,5	0171602503000211	C 27
25	60	CM2 Ø 30 x 1,5	0171602506000211	C 30
25	80	CM2 Ø 30 x 1,5	0171602508000211	C 32
30	30	CM2 Ø 30 x 1,5	0171603003000211	C 30
30	60	CM2 Ø 30 x 1,5	0171603006000211	C 32
30	80	CM2 Ø 30 x 1,5	0171603008000211	C 35
40	60	CM2 Ø 30 x 1,5	0171604006000211	C 35
50	60	CM2 Ø 30 x 1,5	0171605006000211	C 37

CONO MORSE Nº 3 ROSCA DE Ø 30 x 1.5

D	L	TIPO CONO	REFERENCIA	PVP
20	30	CM3 Ø 30 x 1,5	0171602003000212	C 37
20	60	CM3 Ø 30 x 1,5	0171602006000212	C 40
20	80	CM3 Ø 30 x 1,5	0171602008000212	C 42
25	30	CM3 Ø 30 x 1,5	0171602503000212	C 37
25	60	CM3 Ø 30 x 1,5	0171602506000212	C 40
25	80	CM3 Ø 30 x 1,5	0171602508000212	C 40
30	30	CM3 Ø 30 x 1,5	0171603003000212	C 40
30	60	CM3 Ø 30 x 1,5	0171603006000212	C 47
30	80	CM3 Ø 30 x 1,5	0171603008000212	C 50
40	60	CM3 Ø 30 x 1,5	0171604006000212	C 50
40	80	CM3 Ø 30 x 1,5	0171604005000212	C 52
50	60	CM3 Ø 30 x 1,5	0171605006000212	C 50
50	80	CM3 Ø 30 x 1,5	0171605008000212	C 52

El sentido de rotación estándar es a derechas.

En caso de que se precise el sentido de rotación a izquierdas se deberá indicar expresamente en el pedido. Esta opción tiene un incremento en el precio del 20%.

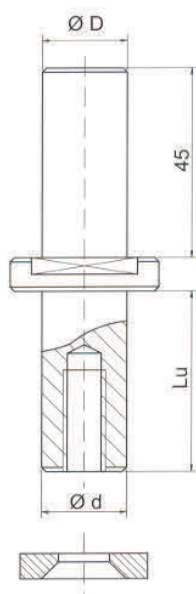

D	L	TIPO CONO	REFERENCIA	PVP
20	30	Ø 20 X 45 mm	0171602003002010	C 12
20	60	Ø 20 X 45 mm	0171602006002010	C 15
20	80	Ø 20 X 45 mm	0171602008002010	C 17
25	30	Ø 20 X 45 mm	0171602503002010	C 12
25	60	Ø 20 X 45 mm	0171602506002010	C 15
25	80	Ø 20 X 45 mm	0171602508002010	C 17
30	30	Ø 20 X 45 mm	0171603003002010	C 12
30	60	Ø 20 X 45 mm	0171603006002010	C 15
30	80	Ø 20 X 45 mm	0171603008002010	C 17
40	60	Ø 20 X 45 mm	0171604006002010	C 17
40	80	Ø 20 X 45 mm	0171604005002010	C 20

El sentido de rotación estándar es a derechas.

En caso de que se precise el sentido de rotación a izquierdas se deberá indicar expresamente en el pedido. Esta opción tiene un incremento en el precio del 20%.

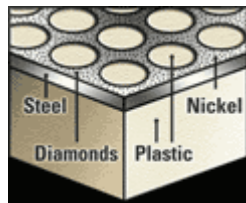

- 1 Base de acero
- 2 Diamantes unidos al níquel
- 3 Huecos
- 4 base de plástico

Afilador formado por una superficie con gran contenido de diamantes mono cristal, donde se intercalan pequeños huecos, que se destinan a la captación del material que se desprende al afilar.

Solo es válido para reafilados. Se emplean para prolongar la vida útil de la herramienta entre afilados convencionales.

Se dispone de cuatro tamaños de grano para las diferentes exigencias del afilado

- Extrafino: De color verde, para súper acabados
- Fino: De color rojo, para afilados convencionales
- Medio: De color azul, para afilados profundos donde requiera sacar bastante material
- Gruesa: De color negro, para desbastes



DENOMINACION	REFERENCIA	PVP
pedra extrafina medidas 152 x 51 x 19 funda plastica	W6EP	B 15
pedra fina medidas 152 x 51 x 19 funda plastica	W6FP	B 15
pedra media medidas 152 x 51 x 19 funda plastica	W6CP	B 15
pedra gruesa medidas 152 x 51 x 19 funda plastica	W6XP	B 15



DENOMINACION	REFERENCIA	PVP
pedra diamantada con mango de plastico grano extrafino	FWE	A 49
pedra diamantada con mango de plastico grano fino	FWF	A 49
pedra diamantada con mango de plastico grano medio	FWC	A 49
pedra diamantada con mango de plastico grano grueso	FWX	A 49



DENOMINACION	REFERENCIA	PVP
pedra diamantada con mango de plastico grano extrafino/fino	FWEF	B 9
pedra diamantada con mango de plastico grano fino / medio	FWFC	B 9
pedra diamantada con mango de plastico grano medio/ grueso	FWCX	B 9



DENOMINACION	REFERENCIA	PVP
pedra diamantada con mango de plastico grano fino para afilado de discos de metal duro por el interior	FFF	A 51



DENOMINACION	REFERENCIA	PVP
Medidor de angulos fabricado en aluminio largo 700mm	ANG,70	B 34
Medidor de angulos fabricado en aluminio largo 700mm con tope lateral	ANG,70S	A 42

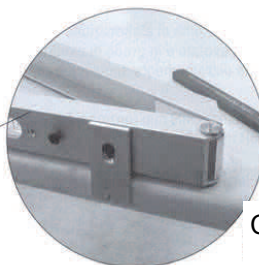
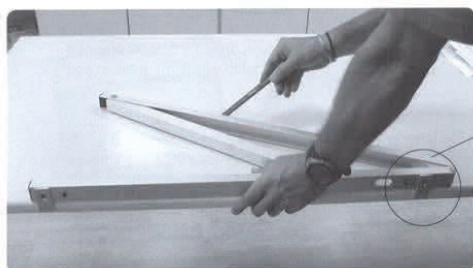

Con tope lateral