

CATÁLOGO

CUCHILLAS

EDICIÓN CCU-13-02

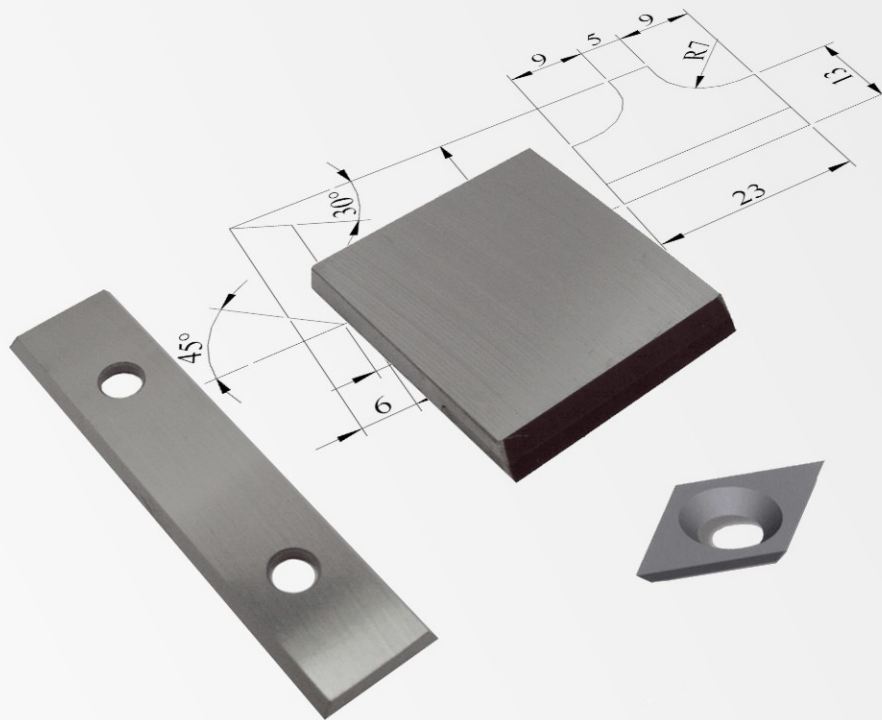

ÍNDICE

CUCHILLAS

	CALIDAD HC05-HC 27. MADERAS BLANDAS	PAG. 210-211
	PRECORTADORES Y REDONDEADORES	PAG. 212-213
	CORTE INCLINADO. CABEZALES PANTÓGRAFO	PAG. 214
	CALIDAD MG18. MADERAS DURAS	PAG. 215
	CALIDAD SMG02. AGLOMERADO Y MDF	PAG. 216
	CALIDAD UMG04. MDF, AGLOMERADO. CEP.ELÉCTRICOS	PAG. 217
	CEPILLOS ELÉCTRICOS	PAG. 218
	CEPILLADORAS	PAG. 219-221
	CORRUGADAS	PAG. 222-223
	KADUR FIX	PAG. 224

ÍNDICE

CUCHILLAS

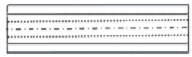

CUCHILLAS TERSA

PAG. 225



CUCHILLAS CENTROLOCK

PAG. 226

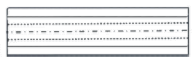

CUCHILLAS TERMINUS

PAG. 227



CUCHILLAS BULLDOZER

PAG. 228

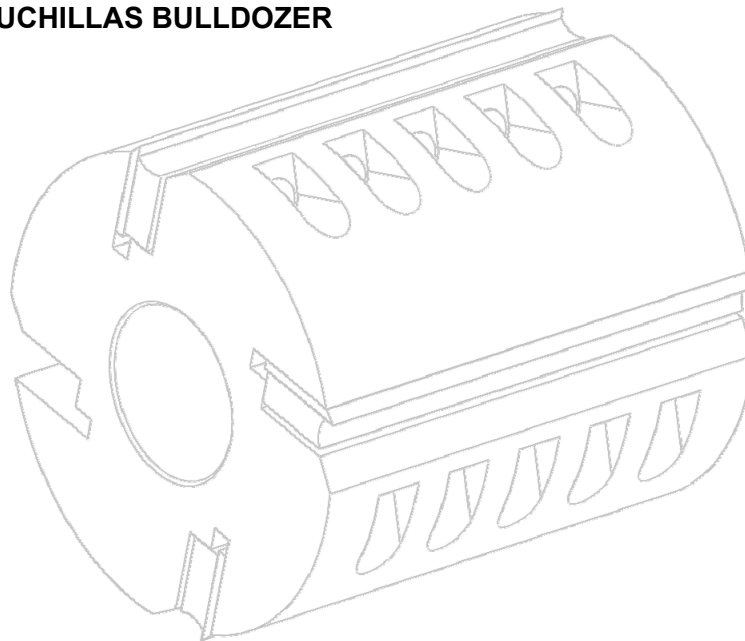

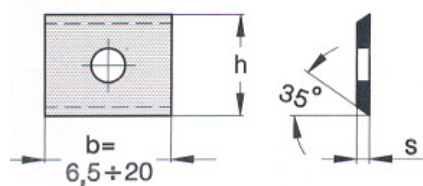

L	H	E	&	CALIDAD	REFERENCIA	PVP
7,5	12	1,5	35°	T04F	0091307501201200	1,65
8,6	12	1,5	35°	T04F	0091308601201500	1,85
9	12	1,5	35°	T04F	0091309051201500	1,95
9,6	12	1,5	35°	T04F	0091309601201500	2,20
10,5	12	1,5	35°	T04F	0091301051201500	2,35
11	12	1,5	35°	T04F	0091301112015000	2,35
13	12	1,5	35°	T04F	0091300131201500	2,45
15	12	1,5	35°	T04F	0091300151201500	2,87
18	12	1,5	35°	T04F	0091300181201500	3,15
20	12	1,5	35°	T04F	0091302001201500	1,70
25	12	1,5	35°	T04F	0091302501201500	2,25

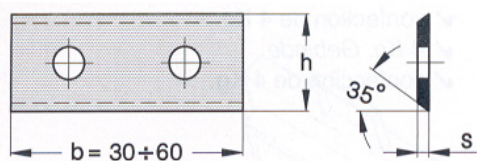

L	H	E	&	CALIDAD	REFERENCIA	PVP
25	12	1,5	35°	T04F	0091302501201501	2,25
30	12	1,5	35°	T04F	0091303001201500	2,00
40	12	1,5	35°	T04F	0091304001201500	2,98
50	12	1,5	35°	T04F	0091305001201500	3,05
60	12	1,5	35°	T04F	0091306001201500	3,98

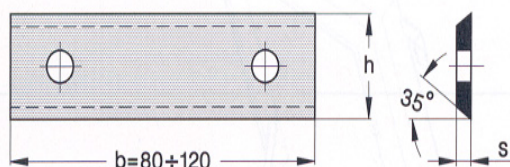

L	H	E	&	CALIDAD	REFERENCIA	PVP
80	13	2,2	35°	T04F	0091306001302201	14,27
100	13	2,2	35°	T04F	0091310001302201	21,65
120	13	2,2	35°	T04F	0091312001302201	26

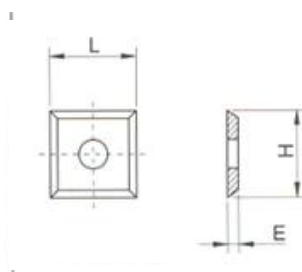

L	H	E	&	CALIDAD	REFERENCIA	PVP
12	12	1,5	35°	T04F	0091301201201500	1,60
17	17	2,0	35°	T04F	0091301701702000	4,70
19	19	2,0	35°	T04F	0091301901902000	4,99

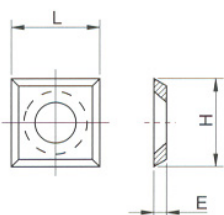

L	H	E	&	CALIDAD	REFERENCIA	PVP
14	14	1,2	35°	T04F	0091301401401200	1,98
14	14	2,0	35°	T04F	0091301401402000	1,50
14,3	14,3	2,5	35°	T10MG	0091301401402500	5,00

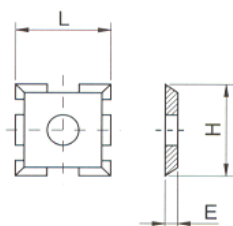

L	H	E	&	CALIDAD	REFERENCIA	PVP
15	15	2,0	35°	T08MF	0091301501502001	5,10

LAS CUCHILLAS SE SUMINISTRAN EN CAJAS DE 10 UNIDADES

ARISTAS BISELADAS PARA CABEZALES HELICOIDA-

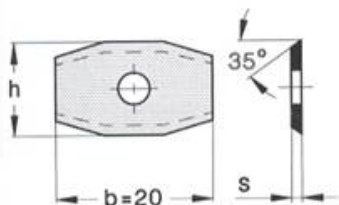

L	H	E	&	CALIDAD	REFERENCIA	PVP
20	12	1,5	35°	T10MG	0091502001201500	3,92
24	12	1,5	40°	HC05	0091502401201500	4,65
24,7	12	1,5	35°	T04F	0091502501201500	4,00

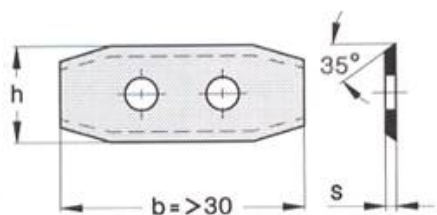

L	H	E	&	CALIDAD	REFERENCIA	PVP
24,7	12	1,5	35°	HC05	0091502401201500	4,62
30	12	1,5	35°	HC05	0091503001201500	4,35
50	12	1,5	35°	HC05	0091505001201500	6,60

CON CORTE LATERAL

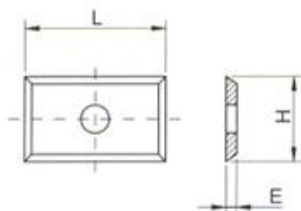

L	H	E	&	CALIDAD	REFERENCIA	PVP
9	12	1,5	35°	HC05	0091300900121500	4,77
10	12	1,5	35°	HC05	0091301001201500	5,50
14,5	12	1,5	35°	HC05	0091301401201500	5,60
19,5	12	1,5	35°	MG06	0091301901201500	5,60
16	7	1,5	35°	MG06	0091505001201500	4,25

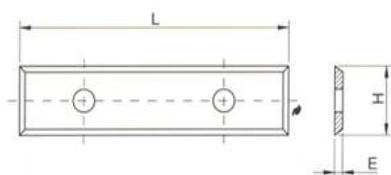

L	H	E	&	CALIDAD	REFERENCIA	PVP
29,5	12	1,5	35°	HC05	0091302901201500	4,30
39,5	12	1,5	35°	HC05	0091303901201500	4,00
49,5	12	1,5	35°	HC05	0091304901201500	4,30
59,5	12	1,5	35°	HC05	0091305901201500	6,67

ANCHO DE 9.0 mm CABEZALES FREUD

SIN CORTE LATERAL

L	H	E	&	CALIDAD	REFERENCIA	PVP
20	9	1,5	35°	T04F	0091302000901500	4,37
30	9	1,5	35°	T04F	0091303000901500	5,60
50	9	1,5	35°	T04F	009130500091500	5,90

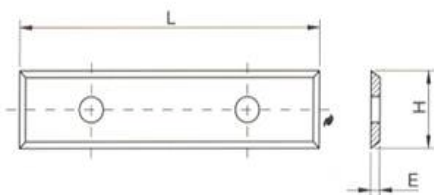

CON CORTE LATERAL

L	H	E	&	CALIDAD	REFERENCIA	PVP
29,5	9	1,5	35°	T04F	0091329501201500	5,07
49,5	9	1,5	35°	T04F	0091349501201500	6,42

LAS CUCHILLAS SE SUMINISTRAN EN CAJAS DE 10 UNIDADES

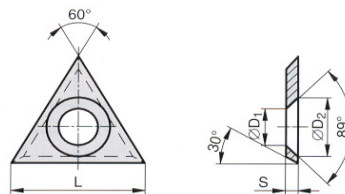
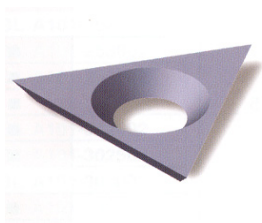

L	E	&	CALIDAD	REFERENCIA	PVP
22	2,0	30°	MG18	0091302200002004	4,15

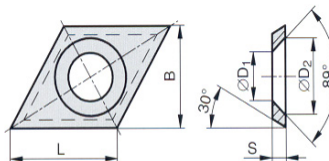
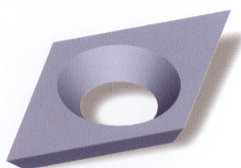

L	E	&	CALIDAD	REFERENCIA	PVP
14	2,0	30°	HC05	0091301400002000	6,65

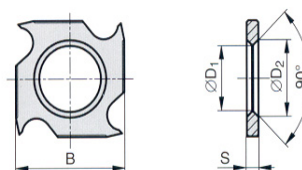
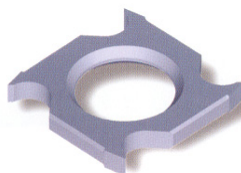

B	B	S	CALIDAD	REFERENCIA	PVP
18	18	1,95	HC20	0091301801819503	4,90
18	18	2,50	HC20	0091301801825003	6,70
18	18	2,95	HC20	0091301801829503	7,40
18	18	3,70	HC20	0091301801837003	10,0
18	18	4,00	HC20	0091301801840003	9,15

B	B	S	CALIDAD	REFERENCIA	PVP
14	14	2,00	HC20	0091301401420003	5,00
14	14	2,5	HC20	0091301401425003	5,37
14	14	3,0	HC20	0091301401423003	6,25

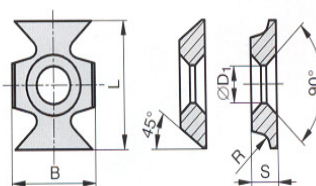

B	L	S	R	CALIDAD	REFERENCIA	PVP
16	22	5,0	BISEL	HC20	0091301602205003	12,85
16	22	5,0	1,0	HC20	0091301602201003	13,35
16	22	5,0	1,5	HC20	0091301602201503	13,35
16	22	5,0	2,0	HC20	0091301602202003	13,35
16	22	5,0	2,5	HC20	0091301602202503	13,35
16	22	5,0	3,0	HC20	0091301602203003	13,35

LAS CUCHILLAS SE SUMINISTRAN EN CAJAS DE 10 UNIDADES

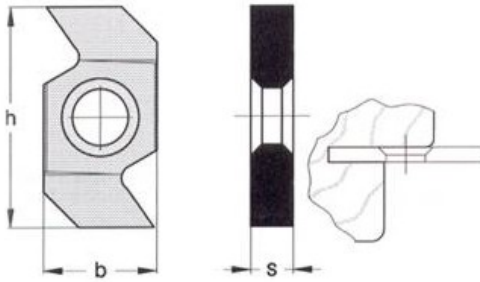

B	H	S	Z	CALIDAD	REFERENCIA	PVP
16	34	3,2	2	HC35	0091301603403202	34,75
16	34	4,0	2	HC35	0091301602404002	36,25
16	34	5,0	2	HC35	0091301603405002	41,75
16	34	6,0	2	T06MF	0091301603406002	48,50
16	34	7,0	2	T06MF	009131603407002	49,90

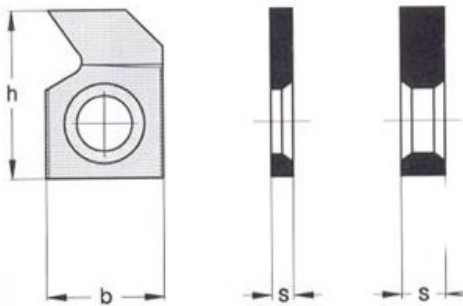

B	H	S	Z	CALIDAD	REFERENCIA	PVP
13	24,5	4	1	HC20	0091301302404003	23,65
13	24,5	5	1	HC20	0091301302405003	24,58

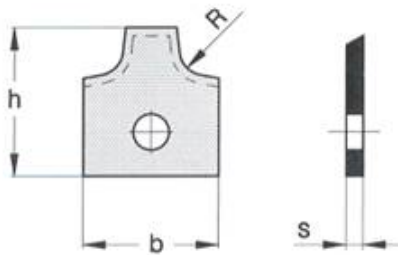

H	B	E	R	CALIDAD	REFERENCIA	PVP
17.5	16	2,0	2	HC05	0091417501600200	A 24
17.5	16	2,0	3	HC05	0091417501600300	A 24
17.5	16	2,0	4	HC05	0091417501600400	A 24
17.5	16	2,0	5	HC05	0091417501600500	A 24

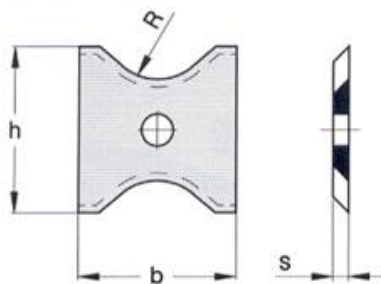

B	H	E	R	CALIDAD	REFERENCIA	PVP
13	16	2,0	2	HC05	0091401301600200	A 25
13	16	2,0	3	HC05	0091401301600300	A 25
13	16	2,0	4	HC05	0091401301600400	A 25
20	21	2,0	5	HC05	0091402002100500	A 31
20	21	2,0	6	HC05	0091402002100600	A 31
20	21	2,0	7	HC05	0091402002100700	A 31
20	21	2,0	8	HC05	0091402002100800	A 31
26	24	2,0	9	HC05	0091402602400900	A 35
26	24	2,0	10	HC05	0091402602401000	A 35
26	24	2,0	11	HC05	0091402602401100	A 35
26	24	2,0	12	HC05	0091402602401200	A 35

LAS CUCHILLAS SE SUMINISTRAN EN CAJAS DE 10 UNIDADES

CUCHILLAS INCLINADAS IZQUIERDAS

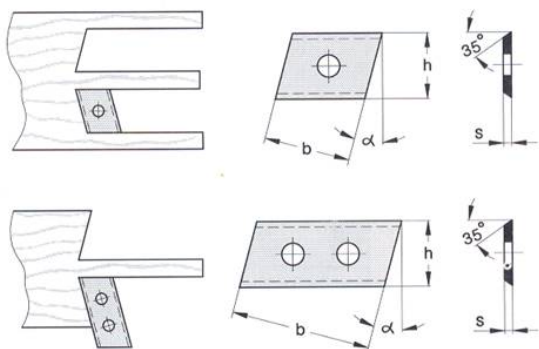

CUCHILLAS INCLINADAS DERECHAS

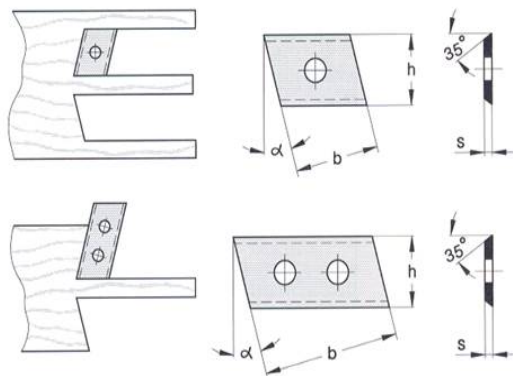

B	H	E	&	CALIDAD	PVP
10 a 19	12	2,0	a determinar	HC05	A 15
20 a 30	12	2,0	a determinar	HC05	A 19
30 a 50	12	2,0	a determinar	HC05	A 21

Es necesario proporcionar una muestra de la cuchilla o un plano debidamente acotado.

MINI CUCHILLAS REVERSIBLES PARA CABEZALES PANTÓGRAFO

RANURA EN LA PARTE POSTERIOR

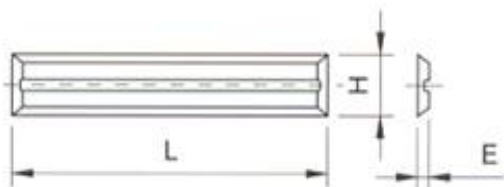

L	H	E	&	CALIDAD	REFERECIA	PVP
12	5,5	1,1	35	HC05	0091301205501100	4,80
20	5,5	1,1	35	HC05	0091302005501100	4,17
25	5,5	1,1	35	HC05	0091302505501100	4,35
30	5,5	1,1	35	HC05	0091303005501100	4,30
40	5,5	1,1	35	HC05	0091304005501100	5,40
50	5,5	1,1	35	HC05	0091305005501100	4,77

RANURA EN LA PARTE DELANTERA

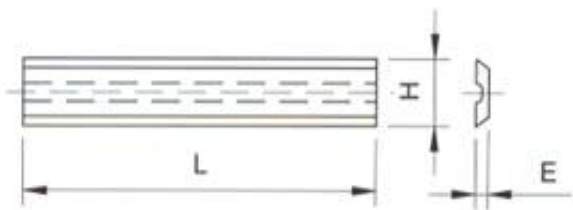

L	H	E	&	CALIDAD	REFERECIA	PVP
12	5,5	1,1	35	HC05	0091301205511100F	2,87
20	5,5	1,1	35	HC05	0091302005511100F	3,05
30	5,5	1,1	35	HC05	0091303005511100F	5,10
40	5,5	1,1	35	HC05	0091304005511100F	4,20
50	5,5	1,1	35	HC05	0091305005511100F	5,10



Con recubrimiento de Titanio

L	H	E	&	CALIDAD	REFERECIA	PVP	
20	5,5	1,1	35	T03MG	0091302005501100	7,50	Corte lateral
20	10	1,5	35	T03MG	0091302001001500	8,50	Corte lateral
30	10	1,5	35	T03MG	0091303001001500	9,15	Corte lateral
50	10	1,5	35	T03MG	0091305001001500	10,97	Corte lateral
50	10	1,5	35	T03MG	0091305001011500	12,00	Corte lateral + bisel

LAS CUCHILLAS SE SUMINISTRAN EN CAJAS DE 10 UNIDADES

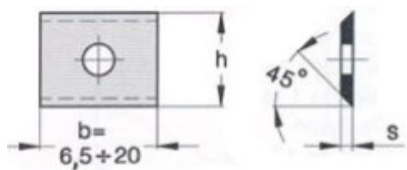

L	H	E	&	CALIDAD	REFERENCIA	PVP
7,5	12	1,5	45°	MG 18	0091307501201204	3,67
15	12	1,5	45°	MG 18	0091301501201504	3,85
20	12	1,5	45°	MG 18	0091302001201504	4,05
24	12	1,5	45°	MG 18	009130240121504	6,60

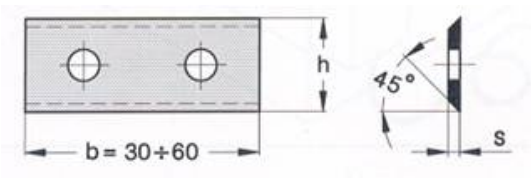

L	H	E	&	CALIDAD	REFERENCIA	PVP
30	12	1,5	45°	MG18	0091303001201504	4,45
40	12	1,5	45°	MG18	0091304001201504	5,85
50	12	1,5	45°	MG18	0091305001201504	5,55
60	12	1,5	45°	MG18	0091306001201504	8,97

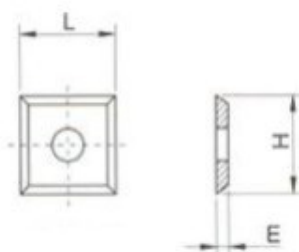

L	H	E	&	CALIDAD	REFERENCIA	PVP
12	12	1,5	45	KCR08	0091301201201504	4,85

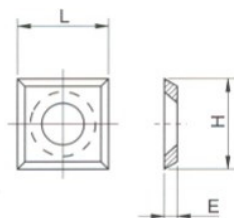

L	H	E	&	CALIDAD	REFERENCIA	PVP
14	14	2,0	45°	MG18	0091301401401204	5,55

La calidad del metal duro es microgramo MG18. Sus características especiales de dureza y tenacidad lo hacen idóneo para trabajar maderas duras. El ángulo de afilado de 45° suaviza la penetración de la cuchilla en la madera, proporcionando un rendimiento muy superior a las calidades convencionales.

LAS CUCHILLAS SE SUMINISTRAN EN CAJAS DE 10 UNIDADES

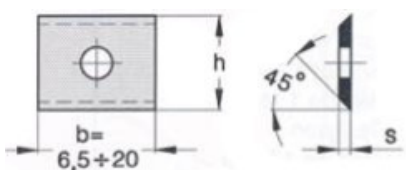

L	H	E	&	CALIDAD	REFERENCIA	PVP
9,6	12	1,5	35°	SMG02	0091309601201506	3,95
15	12	1,5	35°	SMG02	0091301501201506	4,17
20	12	1,5	35°	SMG02	0091302001501206	3,35

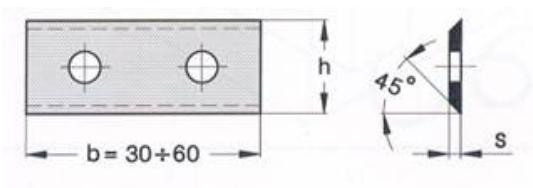

L	H	E	&	CALIDAD	REFERENCIA	PVP
30	12	1,5	35°	SMG02	0091303001201506	4,65
40	12	1,5	35°	SMG02	0091304001201506	4,70
50	12	1,5	35°	SMG02	0091305001201506	6,65
60	12	1,5	35	SMG02	0091306001201506	9,72

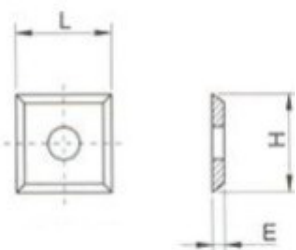

L	H	E	&	CALIDAD	REFERENCIA	PVP
12	12	1,5	35	SMG02	0091301201201506	3,97

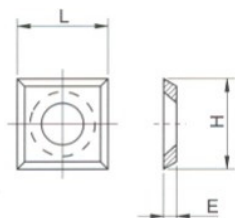

L	H	E	&	CALIDAD	REFERENCIA	PVP
14	14	2,0	35°	SMG02	0091301401401206	4,15

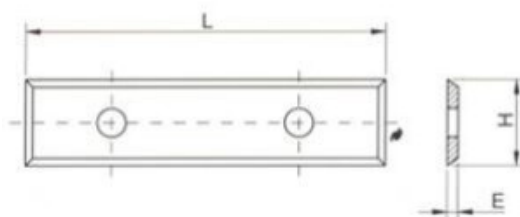

CON CORTE LATERAL

L	H	E	&	CALIDAD	REFERENCIA	PVP
19,5	12	1,5	35°	SMG02	0091301901201506	8,55
29,5	12	1,5	35°	SMG02	0091302901201506	8,55
49,5	12	1,5	35°	SMG02	0091304901201506	8,87
59,5	12	1,5	35°	SMG02	0091305901201506	12,85

La calidad del metal duro es Micrograno SMG02, cuyas características la hacen apropiada para trabajar aglomerado recubierto de melanina y tablero MDF.

LAS CUCHILLAS SE SUMINISTRAN EN CAJAS DE 10 UNIDADES

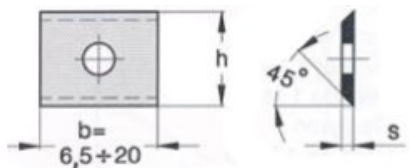

L	H	E	&	CALIDAD	REFERENCIA	PVP
20	12	1,5	35°	UMG04	0091302001201507	5,20

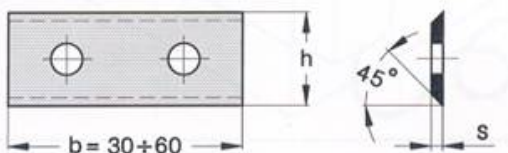

L	H	E	&	CALIDAD	REFERENCIA	PVP
30	12	1,5	35°	UMG04	0091303001201507	8,25
50	12	1,5	35°	UMG04	0091305001201507	10,40

La calidad del metal duro es ULTRAMICRON UMG04. Su principal característica es que su duración es tres veces superior a la SMG02, y diez veces mayor que las calidades convencionales.
Solo se recomienda para trabajar MDF

**MINI CUCHILLAS REVERSIBLES PARA CABEZALES DE PANTÓGRAFO RANURA
EN LA PARTE POSTERIOR Y CORTE LATERAL**

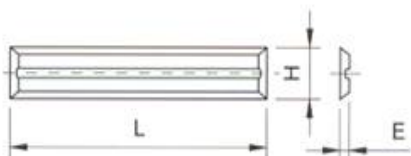

L	H	E	&	CALIDAD	REFERENCIA	PVP
20	5,5	1,1	35	MG06	0091302005501105	5,42
30	5,5	1,1	35	MG06	0091303005501105	5,82
40	5,5	1,1	35	MG06	0091304005501105	6,17
50	5,5	1,1	35	MG06	0091305005501105	6,90

MINI CUCHILLAS REVERSIBLES PARA CEPILLOS ELÉCTRICOS

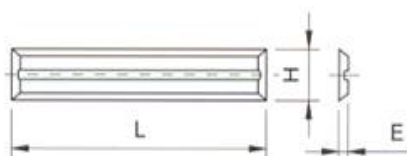

L	H	E	MAQUINA	CALIDAD	REFERENCIA	PVP
75.5	5,5	1,1	AEG - BOSCH - FESTO - HAFFNER - MAFELL - METABO	T08MF	0091375505501102	2,3
78	5,5	1,1	VIRUTEX	T08MF	0091307805501102	2,32
80,5	5,9	1,2	ELU	T08MF	0091380505901202	2,95
82	5,5	1,1	AEG - MAFELL - B&D - BOSCH - MAKITA - METABO	T08MF	0091308205501102	2,32
92	5,5	1,1	AEG - HITACHI RYOBI	T08MF	0091309205501102	4,0
102	5,5	5,0	BLACK & DECKER - AEG	T08MF	0091301602203003	8,45

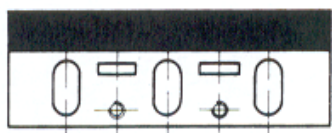

BLACK & DECKER - MAKITA - AICHI			
DIMENSIONES DE LA CUCHILLA 82 x 29 x 3,0 mm			
REFERENCIA METAL DURO	PVP	REFERENCIA ACERO RAPIDO	PVP
0091008202603000	A 29	0081008202903000	A 20



ELU			
DIMENSIONES DE LA CUCHILLA 80 x 27 x 2,9 mm			
REFERENCIA METAL DURO	PVP	REFERENCIA ACERO RAPIDO	PVP
0091008002702900	A 29	0081008002702900	A 21

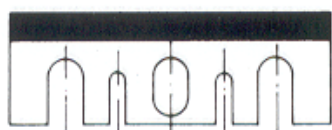

HITACHI			
DIMENSIONES DE LA CUCHILLA 82 x 28 x 3,0 mm			
REFERENCIA METAL DURO	PVP	REFERENCIA ACERO RAPIDO	PVP
0091008202803000	A 30	0081008202803000	A 21



HITACHI			
DIMENSIONES DE LA CUCHILLA 92 x 30 x 3,0 mm			
REFERENCIA METAL DURO	PVP	REFERENCIA ACERO RAPIDO	PVP
0091009203003000	A 35	0081009203003000	A 22



METABO			
DIMENSIONES DE LA CUCHILLA 62 x 22 x 3,0 mm			
REFERENCIA METAL DURO	PVP	REFERENCIA ACERO RAPIDO	PVP
0091006202203000	A 29	0081006202203000	A 21



RYOBI			
DIMENSIONES DE LA CUCHILLA 92 x 29 x 3,0 mm			
REFERENCIA METAL DURO	PVP	REFERENCIA ACERO RAPIDO	PVP
0091009202903000	A 35	0081009202903000	A 22

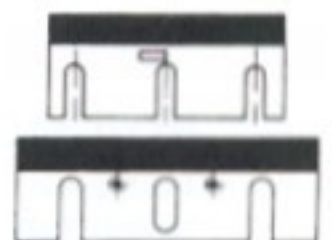

SKIL			
DIMENSIONES DE LA CUCHILLA 77 x 28,6 x 3,2 82 x 29 x 3,0 mm			
REFERENCIA METAL DURO	PVP	REFERENCIA ACERO RAPIDO	PVP
0091007728631500	A 30	0081007728631500	A 21

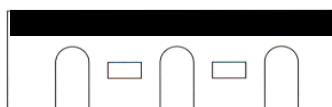

VIRUTEX			
DIMENSIONES DE LA CUCHILLA 78 x 25 x 3,2			
REFERENCIA METAL DURO	PVP	REFERENCIA ACERO RAPIDO	PVP
0091007802503200	A 27	0081007802503200	A 18

LAS CUCHILLAS SE SUMINISTRAN EN CAJAS DE 2 UNIDADES



B	H	S	REFERENCIA	PVP
270	20	3	00810270020003	A 21
310	20	3	00810310020003	A 23
350	20	3	00810350020003	A 24

B	H	S	REFERENCIA	PVP
60	25	3	00810060025003	A 5
80	25	3	00810080025003	A 7
90	25	3	00810090025003	A 8
100	25	3	00810100025003	A 9
110	25	3	00810110025003	A 11
120	25	3	00810120025003	A 11
130	25	3	00810130025003	A 12
140	25	3	00810140025003	A 13
150	25	3	00810150025003	A 13
160	25	3	00810160025003	A 15
180	25	3	00810180025003	A 17
200	25	3	00810200025003	A 18
210	25	3	00810210025003	A 19
230	25	3	00810230025003	A 20
240	25	3	00810240025003	A 21
250	25	3	00810250025003	A 21
260	25	3	00810260025003	A 22
300	25	3	00810300025003	A 23
310	25	3	00810310025003	A 24
350	25	3	00810350025003	A 25
400	25	3	00810400025003	A 28
410	25	3	00810410025003	A 28
500	25	3	00810500025003	A 32
510	25	3	00810510025003	A 33

B	H	S	REFERENCIA	PVP
60	30	3	00810060030003	A 6
80	30	3	00810080030003	A 8
90	30	3	00810090030003	A 9
100	30	3	00810100030003	A 10
110	30	3	00810110030003	A 11
120	30	3	00810120030003	A 12
130	30	3	00810130030003	A 13
140	30	3	00810140030003	A 14
150	30	3	00810150030003	A 15
160	30	3	00810160030003	A 16
170	30	3	00810170030003	A 17
180	30	3	00810180030003	A 18
190	30	3	00810190030003	A 19
200	30	3	00810200030003	A 19
210	30	3	00810210030003	A 20
230	30	3	00810230030003	A 21
240	30	3	00810240030003	A 21
250	30	3	00810250030003	A 22
260	30	3	00810260030003	A 23
300	30	3	00810300030003	A 24
310	30	3	00810310030003	A 25
350	30	3	00810350030003	A 27
400	30	3	00810400030003	A 29
410	30	3	00810410030003	A 30
450	30	3	00810450030003	A 32
500	30	3	00810500030003	A 34
510	30	3	00810510030003	A 35
520	30	3	00810520030003	A 36
530	30	3	00810530030003	A 39
600	30	3	00810600030003	A 40
610	30	3	00810610030003	A 41
630	30	3	00810630030003	A 42
640	30	3	00810640030003	A 44
670	30	3	00810670030003	A 45
710	30	3	00810710030003	A 51
810	30	3	00810810030003	B 1
860	30	3	00810860030003	B 2
870	30	3	00810870030003	B 6
1010	30	3	008101010030003	B 7

B	H	S	REFERENCIA	PVP
60	35	3	00810060035003	A 6
80	35	3	00810080035003	A 8
90	35	3	00810090035003	A 9
100	35	3	00810100035003	A 11
110	35	3	00810110035003	A 12
120	35	3	00810120035003	A 13
130	35	3	00810130035003	A 14
140	35	3	00810140035003	A 15
150	35	3	00810150035003	A 16
160	35	3	00810160035003	A 17
170	35	3	00810170035003	A 18
180	35	3	00810180035003	A 19
190	35	3	00810190035003	A 20
200	35	3	00810200035003	A 21
210	35	3	00810210035003	A 21
230	35	3	00810230035003	A 22
240	35	3	00810240035003	A 22
250	35	3	00810250035003	A 23
260	35	3	00810260035003	A 23
300	35	3	00810300035003	A 26
310	35	3	00810310035003	A 28
350	35	3	00810350035003	A 29
400	35	3	00810400035003	A 31
410	35	3	00810410035003	A 32
450	35	3	00810450035003	A 33
500	35	3	00810500035003	A 37
510	35	3	00810510035003	A 37
520	35	3	00810520035003	A 38
530	35	3	00810530035003	A 38
600	35	3	00810600035003	A 41
610	35	3	00810610035003	A 42
630	35	3	00810630035003	A 44
640	35	3	00810640035003	A 45
670	35	3	00810670035003	A 46
710	35	3	00810710035003	A 48
810	35	3	00810810035003	B 1
860	35	3	00810860035003	B 3
870	35	3	00810870035003	B 3
1010	35	3	008101010035003	B 8



B	H	S	REFERENCIA	PVP	B	H	S	REFERENCIA	PVP	B	H	S	REFERENCIA	PVP
60	25	3	00910060025003	A 24	60	30	3	00910060030003	A 24	60	35	3	00910060035003	A 24
80	25	3	00910080025003	A 29	80	30	3	00910080030003	A 29	80	35	3	00910080035003	A 29
90	25	3	00910090025003	A 31	90	30	3	00910090030003	A 31	90	35	3	00910090035003	A 31
100	25	3	00910100025003	A 34	100	30	3	00910100030003	A 34	100	35	3	00910100035003	A 34
110	25	3	00910110025003	A 36	110	30	3	00910110030003	A 36	110	35	3	00910110035003	A 36
120	25	3	00910120025003	A 39	120	30	3	00910120030003	A 39	120	35	3	00910120035003	A 39
130	25	3	00910130025003	A 41	130	30	3	00910130030003	A 41	130	35	3	00910130035003	A 41
140	25	3	00910140025003	A 44	140	30	3	00910140030003	A 44	140	35	3	00910140035003	A 44
150	25	3	00910150025003	A 46	150	30	3	00910150030003	A 46	150	35	3	00910150035003	A 46
160	25	3	00910160025003	A 48	160	30	3	00910160030003	A 48	160	35	3	00910160035003	A 48
170	25	3	00910170025003	A 51	170	30	3	00910170030003	A 51	170	35	3	00910170035003	A 51
180	25	3	00910180025003	B 1	180	30	3	00910180030003	B 1	180	35	3	00910180035003	B 1
190	25	3	00910190025003	B 2	190	30	3	00910190030003	B 2	190	35	3	00910190035003	B 2
200	25	3	00910200025003	B 4	200	30	3	00910200030003	B 4	200	35	3	00910200035003	B 4
210	25	3	00910210025003	B 5	210	30	3	00910210030003	B 5	210	35	3	00910210035003	B 5
230	25	3	00910230025003	B 8	230	30	3	00910230030003	B 8	230	35	3	00910230035003	B 8
240	25	3	00910240025003	B 9	240	30	3	00910240030003	B 9	240	35	3	00910240035003	B 9
250	25	3	00910250025003	B 10	250	30	3	00910250030003	B 10	250	35	3	00910250035003	B 10
260	25	3	00910260025003	B 11	260	30	3	00910260030003	B 11	260	35	3	00910260035003	B 11
300	25	3	00910300025003	B 16	300	30	3	00910300030003	B 16	300	35	3	00910300035003	B 16
310	25	3	00910310025003	B 17	310	30	3	00910310030003	B 17	310	35	3	00910310035003	B 17
350	25	3	00910350025003	B 22	350	30	3	00910350030003	B 22	350	35	3	00910350035003	B 22
400	25	3	00910400025003	B 28	400	30	3	00910400030003	B 28	400	35	3	00910400035003	B 28
410	25	3	00910410025003	B 30	410	30	3	00910410030003	B 30	410	35	3	00910410035003	B 30
450	25	3	00910450025003	B 34	450	30	3	00910450030003	B 34	450	35	3	00910450035003	B 34
500	25	3	00910500025003	B 40	500	30	3	00910500030003	B 40	500	35	3	00910500035003	B 40
510	25	3	00910510025003	B 42	510	30	3	00910510030003	B 42	510	35	3	00910510035003	B 42
560	25	3	00910560025003	B 48	520	30	3	00910520030003	B 43	520	35	3	00910520035003	B 43
600	25	3	00910600025003	C 1	530	30	3	00910530030003	B 46	530	35	3	00910530035003	B 47
610	25	3	00910610025003	C 2	560	30	3	00910560030003	B 48	560	35	3	00910560035003	B 48
					600	30	3	00910600030003	C 1	600	35	3	00910600035003	C 1
					610	30	3	00910610030003	C 2	610	35	3	00910610035003	C 2
					630	30	3	00910630030003	C 4	630	35	3	00910630035003	C 4
					640	30	3	00910640030003	C 6	640	35	3	00910640035003	C 6
					710	30	3	00910710030003	C 14	710	35	3	00910710035003	C 14
					810	30	3	00910810030003	C 26	810	35	3	00910810035003	C 26
					860	30	3	00910860030003	C 32	860	35	3	00910860035003	C 32
					1010	30	3	009101010030003	C 52	1010	35	3	009101010035003	C 52
					1060	30	3	009101060030003	D 5	1060	35	3	009101060035003	D 5



B	H	S	REFERENCIA	PVP
50	30	3	00911050030003	A 30
60	30	3	00911060030003	A 33
80	30	3	00911080030003	A 42
100	30	3	00911100030003	A 47
110	30	3	00911110025003	B 1
120	30	3	00911120030003	B 1
130	30	3	00911130030003	B 3
150	30	3	00911150030003	B 7
160	30	3	00911160030003	B 8
170	30	3	00911170030003	B 12
180	30	3	00911180030003	B 12
210	30	3	00911210030003	B 17
230	30	3	00911230030003	B 21
240	30	3	00911240030003	B 23
260	30	3	00911260030003	B 27
270	30	3	00911270030003	B 29
310	30	3	00911310030003	B 36
330	30	3	00911330030003	B 39

B	H	S	REFERENCIA	PVP
80	30	3	00911408030003	A 37
100	30	3	00911100030003	A 43
120	30	3	00911120030003	A 47
130	30	3	00911130030003	A 50
150	30	3	00911150030003	B 2
180	30	3	00911180030003	B 6
230	30	3	00911230030003	B 14
240	30	3	00911240030003	B 16
250	30	3	00912530030003	B 17
300	30	3	00911300030003	B 25
310	30	3	00911310030003	B 26
350	30	3	00911350030003	B 33
400	30	3	00911400030003	B 40
410	30	3	00911410030003	B 43
430	30	3	00911430030003	B 44
500	30	3	00911500030003	C 3
510	30	3	00911510030003	C 6
530	30	3	00911530030003	C 15
600	30	3	00911600030003	C 23
610	30	3	00911610030003	C 24
630	30	3	00911630030003	C 24
640	30	3	00911640030003	C 25
810	30	3	00911810030003	C 52

B	H	S	REFERENCIA	PVP
50	35	3	00911050035003	A 37
60	35	3	00911060035003	A 37
80	35	3	00911080035003	A 46
100	35	3	00911100035003	A 51
110	35	3	00911110035003	B 2
120	35	3	00911120035003	B 4
130	35	3	00911130035003	B 6
150	35	3	00911150035003	B 11
160	35	3	00911160035003	B 12
170	35	3	00911170035003	B 13
180	35	3	00911180035003	B 15
210	35	3	00911210035003	B 23
230	35	3	00911230035003	B 28
240	35	3	00911240035003	B 29
260	35	3	00911260035003	B 34
270	35	3	00911270035003	B 36
310	35	3	00911310035003	B 44
330	35	3	00911330035003	B 48

B	H	S	REFERENCIA	PVP
80	35	3	00911408035003	A 37
100	35	3	00911100035003	A 43
120	35	3	00911120035003	A 47
130	35	3	00911130035003	A 50
150	35	3	00911150035003	B 2
180	35	3	00911180035003	B 6
230	35	3	00911230035003	B 14
240	35	3	00911240035003	B 16
250	35	3	00912530035003	B 17
300	35	3	00911300035003	B 25
310	35	3	00911310035003	B 26
350	35	3	00911350035003	B 33
400	35	3	00911400035003	B 40
410	35	3	00911410035003	B 43
430	35	3	00911430035003	B 44
500	35	3	00911500035003	C 3
510	35	3	00911510035003	C 6
530	35	3	00911530035003	C 15
600	35	3	00911600035003	C 23
610	35	3	00911610035003	C 24
630	35	3	00911630035003	C 24
640	35	3	00911640035003	C 25
810	35	3	00911810035003	C 52

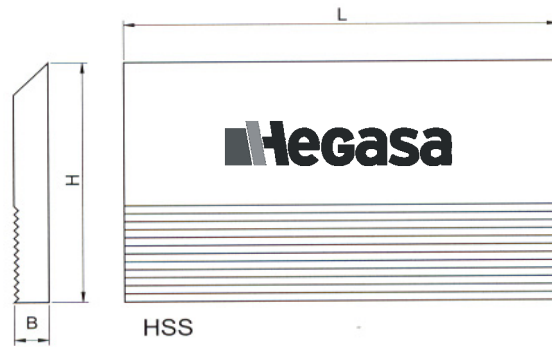

L	H	D	REFERENCIA	PVP
40	40	8	00811040040008	A 24
50	40	8	00811050040008	A 27
60	40	8	00811060040008	A 29
70	40	8	00811070040008	A 31
80	40	8	00811080040008	A 33
90	40	8	00811090040008	A 35
100	40	8	00811100040008	A 36
120	40	8	00811120040008	A 41
130	40	8	00811130040008	A 44
150	40	8	00811150040008	A 50
170	40	8	00811170040008	B 3
180	40	8	00811180040008	B 4

L	H	D	REFERENCIA	PVP
40	50	8	00811040050008	A 25
50	50	8	00811050050008	A 28
60	50	8	00811060050008	A 30
70	50	8	00811070050008	A 32
80	50	8	00811080050008	A 34
90	50	8	00811090050008	A 36
100	50	8	00811100050008	A 38
120	50	8	00811120050008	A 42
130	50	8	00811130050008	A 45
150	50	8	00811150050008	A 52
170	50	8	00811170050008	B 4
180	50	8	00811180050008	B 5

L	H	D	REFERENCIA	PVP
40	70	8	00811040070008	B 27
50	70	8	00811050070008	B 32
60	70	8	00811060070008	B 34
70	70	8	00811070070008	B 39
80	70	8	00811080070008	B 40
90	70	8	00811090070008	B 41
100	70	8	00811100070008	D 45
120	70	8	00811120070008	B 51
130	70	8	00811130070008	B 27
150	70	8	00811150070008	B 51
170	70	8	00811170070008	B 9
180	70	8	00811180070008	B 10

L	H	D	REFERENCIA	PVP
40	60	8	00811040060008	A 26
50	60	8	00811050060008	A 30
60	60	8	00811060060008	A 32
70	60	8	00811070060008	A 35
80	60	8	00811080060008	A 36
90	60	8	00811090060008	A 39
100	60	8	00811100060008	A 40
120	60	8	00811120060008	A 45
130	60	8	00811130060008	A 48
150	60	8	00811150060008	B 2
170	60	8	00811170060008	B 5
180	60	8	00811180060008	B 6

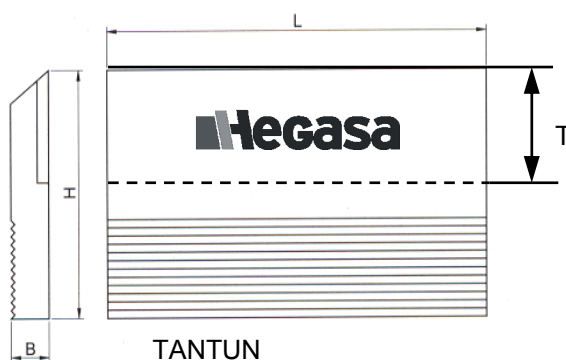
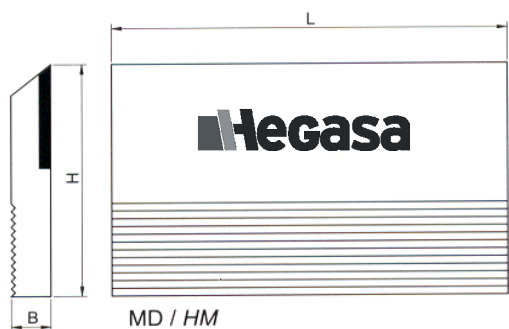

L	H	D	REFERENCIA	PVP
40	50	10	00911040050010	A 40
60	50	10	00911060050010	B 3
80	50	10	00911080050010	B 10
100	50	10	00911100050010	B 18
130	50	10	00911130050010	B 25
150	50	10	00911150050010	B 30
180	50	10	00911150050010	B 39
230	50	10	00911230050010	B 52
260	60	10	00911260050010	C 6

L	H	D	T	REFERENCIA	PVP
40	55	10	25	01111040055010	B 1
50	55	10	25	01111050055010	B 5
60	55	10	25	01111060055010	B 9
80	55	10	25	01111080055010	B 17
100	55	10	25	01111100055010	B 24
130	55	10	25	01111130055010	B 36
150	55	10	25	01111150055010	B 44
165	55	10	25	01111165055010	B 49
180	55	10	25	01111180055010	C 3
210	55	10	25	01111210055010	C 11
230	55	10	32	01111230055010	C 23

L	H	D	REFERENCIA	PVP
40	60	10	00911040060010	A 47
60	60	10	00911060060010	B 8
80	60	10	00911080060010	B 17
100	60	10	00911100060010	B 27
130	60	10	00911130060010	B 37
150	60	10	00911150060010	B 43
180	60	10	00911150060010	B 52
230	60	10	00911230060010	C 15
260	60	10	00911260060010	C 25

L	H	D	T	REFERENCIA	PVP
40	60	10	32	01111040060010	B 4
50	60	10	32	01111050060010	B 9
60	60	10	32	01111060060010	B 14
80	60	10	32	01111080060010	B 24
100	60	10	32	01111100060010	B 32
130	60	10	32	01111130060010	B 46
150	60	10	32	01111150060010	C 3
165	60	10	32	01111165060010	C 11
180	60	10	32	01111180060010	C 17
210	60	10	32	01111210060010	C 32
230	60	10	32	01111230060010	C 42

L	H	D	REFERENCIA	PVP
40	70	10	00911040070010	B 1
60	70	10	00911060070010	B 14
80	70	10	00911080070010	B 23
100	70	10	00911100070010	B 34
130	70	10	00911130070010	B 50
150	70	10	00911150070010	C 2
180	70	10	00911150070010	C 12
230	70	10	00911230070010	C 30
260	70	10	00911260070010	C 42

L	H	D	T	REFERENCIA	PVP
40	70	10	45	01111040070010	B 7
50	70	10	45	01111050070010	B 13
60	70	10	45	01111060070010	B 18
80	70	10	45	01111080070010	B 30
100	70	10	45	01111100070010	B 40
130	70	10	45	01111130070010	C 5
150	70	10	45	01111150070010	C 15
165	70	10	45	01111165070010	C 24
180	70	10	45	01111180070010	C 32
210	70	10	45	01111210070010	C 43
230	70	10	45	01111230070010	D 6

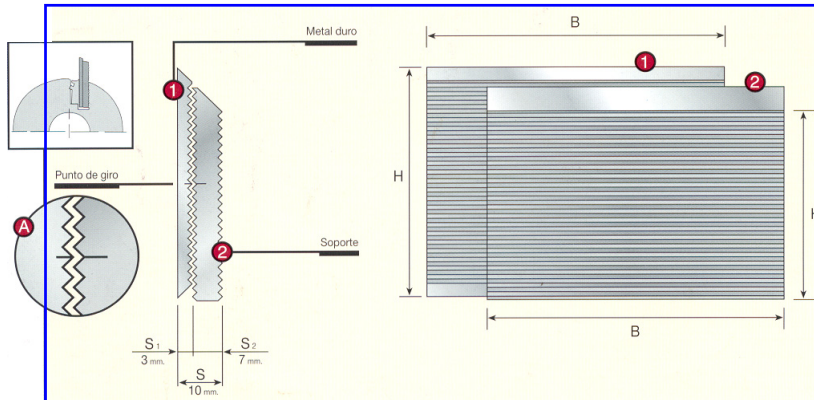

CUCHILLA COMPLETA

B	H	S	REFERENCIA	PVP
40	40	10	00912040040010	B 7
60	40	10	00912060040010	B 20
80	40	10	00912080040010	B 34
100	40	10	00912100040010	B 47
120	40	10	00912120040010	C 9
130	40	10	00912130040010	C 16
150	40	10	00912150040010	C 29
40	50	10	00912040050010	B 9
60	50	10	00912060050010	B 23
80	50	10	00912080050010	B 38
100	50	10	00912100050010	C 16
120	50	10	00912120050010	C 15
130	50	10	00912130050010	C 23
150	50	10	00912150050010	C 37
40	60	10	00912040060010	B 11
60	60	10	00912060060010	B 27
80	60	10	00912080060010	B 42
100	60	10	00912100060010	C 6
120	60	10	00912120060010	C 22
130	60	10	00912130060010	C 30
150	60	10	00912150060010	C 45

CUCHILA DE METAL DURO

B	H	S	REFERENCIA	PVP
40	40	3,0	00912040040003	B 4
60	40	3,0	00912060040003	B 16
80	40	3,0	00912080040003	B 28
100	40	3,0	00912100040003	B 40
120	40	3,0	00912120040003	B 52
130	40	3,0	00912130040003	C 6
150	40	3,0	00912150040003	C 18
40	50	3,0	00912040050003	B 52
60	50	3,0	00912060050003	B 18
80	50	3,0	00912080050003	B 30
100	50	3,0	00912100050003	B 44
120	50	3,0	00912120050003	C 4
130	50	3,0	00912130050003	C 10
150	50	3,0	00912150050003	C 23
40	60	3,0	00912040060003	B 6
60	60	3,0	00912060060003	B 19
80	60	3,0	00912080060003	B 33
100	60	3,0	00912100060003	B 46
120	60	3,0	00912120060003	C 7
130	60	3,0	00912130060003	C 14
150	60	3,0	00912150060003	C 27

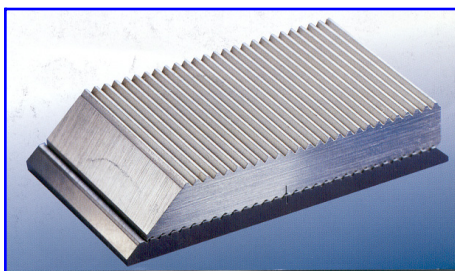

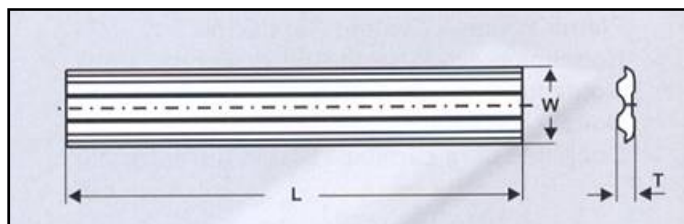

BLACK OXIDE HSS 18% co

B	H	S	REFERENCIA	PVP
60	10	2,35	00817060010235	A 8
80	10	2,35	00817080010235	A 10
100	10	2,35	00817100010235	A 11
120	10	2,35	00817120010235	A 13
130	10	2,35	00817130010235	A 13
150	10	2,35	00817150010235	A 15
180	10	2,35	00817180010235	A 16
200	10	2,35	00817200010235	A 17
210	10	2,35	00817210010235	A 18
230	10	2,35	00817230010235	A 19
250	10	2,35	00817250010235	A 19
270	10	2,35	00817270010235	A 20
300	10	2,35	00817300010235	A 21
310	10	2,35	00817310010235	A 22
330	10	2,35	00817330010235	A 23
350	10	2,35	00817350010235	A 23
400	10	2,35	00817400010235	A 25
410	10	2,35	00817410010235	A 25
430	10	2,35	00817430010235	A 26
450	10	2,35	00817450010235	A 27
500	10	2,35	00817500010235	A 28
510	10	2,35	00817510010235	A 28
530	10	2,35	00817530010235	A 29
550	10	2,35	00817550010235	A 30
600	10	2,35	00817600010235	A 32
610	10	2,35	00817610010235	A 32
630	10	2,35	00817630010235	A 33
640	10	2,35	00817640010235	A 34

METAL DURO

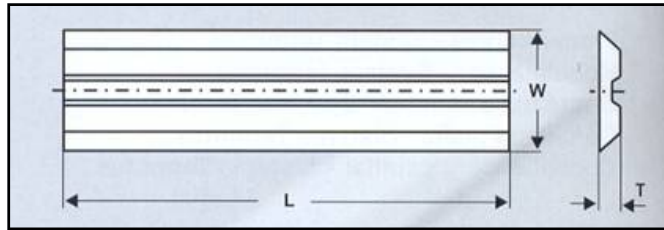
B	H	S	REFERENCIA	PVP
60	10	2,35	00917060010235	A 34
80	10	2,35	00917080010235	A 41
100	10	2,35	00917100010235	A 50
120	10	2,35	00917120010235	S 1
130	10	2,35	00917130010235	B 5
150	10	2,35	00917150010235	B 9
180	10	2,35	00917180010235	B 15
200	10	2,35	00917200010235	B 18
210	10	2,35	00917210010235	B 20
230	10	2,35	00917230010235	B 25
250	10	2,35	00917250010235	B 29
270	10	2,35	00917270010235	B 32
300	10	2,35	00917300010235	B 38
310	10	2,35	00917310010235	B 40
330	10	2,35	00917330010235	B 44
350	10	2,35	00917350010235	B 47
400	10	2,35	00917400010235	C 5
410	10	2,35	00917410010235	C 6
430	10	2,35	00917430010235	C 10
450	10	2,35	00917450010235	C 15
500	10	2,35	00917500010235	C 24
510	10	2,35	00917510010235	C 26
530	10	2,35	00917530010235	C 29
550	10	2,35	00917550010235	C 34
600	10	2,35	00917600010235	C 43
610	10	2,35	00917610010235	C 46
630	10	2,35	00917630010235	C 49
640	10	2,35	00917640010235	C 52



BLACK OXIDE HSS 18% co

B	H	S	REFERENCIA	PVP
60	16	3	00818060016003	A 9
70	16	3	00818070016003	A 10
80	16	3	00818080016003	A 20
100	16	3	00818100016003	A 15
110	16	3	00818110016003	A 16
130	16	3	00818130016003	A 16
150	16	3	00818150016003	A 18
160	16	3	00818160016003	A 20
170	16	3	00818170016003	A 20
180	16	3	00818180016003	A 21
200	16	3	00818200016003	A 22
210	16	3	00818210016003	A 23
220	16	3	00818220016003	A 23
230	16	3	00818230016003	A 24
240	16	3	00818240016003	A 25
250	16	3	00818250016003	A 26
260	16	3	00818260016003	A 27
270	16	3	00818270016003	A 28
280	16	3	00818280016003	A 30
290	16	3	00818290016003	A 31
310	16	3	00818310016003	A 32

METAL DURO

B	H	S	REFERENCIA	PVP
60	16	3	00918060016003	A 37
70	16	3	00918070016003	A 46
80	16	3	00918080016003	A 46
100	16	3	00918100016003	A 48
110	16	3	00918110016003	B 4
130	16	3	00918130016003	B 7
150	16	3	00918150016003	B 11
160	16	3	00918160016003	B 15
170	16	3	00918170016003	B 15
180	16	3	00918180016003	B 18
200	16	3	00918200016003	B 22
210	16	3	00918210016003	B 24
220	16	3	00918220016003	B 25
230	16	3	00918230016003	B 27
240	16	3	00918240016003	B 30
250	16	3	00918250016003	B 32
260	16	3	00918260016003	B 34
270	16	3	00918270016003	B 37
280	16	3	00918280016003	B 38
290	16	3	00918290016003	B 40
310	16	3	00918310016003	B 41

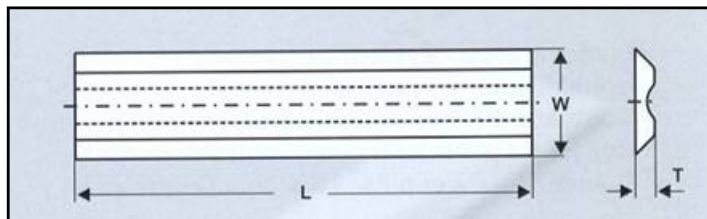
BLACK OXIDE HSS 18% co

B	H	S	REFERENCIA	PVP
60	14	2,55	00819060014255	A 19
80	14	2,55	00819080014255	A 20
100	14	2,55	00819100014255	A 21
120	14	2,55	00819120014255	A 22
130	14	2,55	00819130014255	A 24
140	14	2,55	00819140014255	A 24
150	14	2,55	00819150014255	A 25
160	14	2,55	00819160014255	A 27
170	14	2,55	00819170014255	A 28
180	14	2,55	00819180014255	A 28
190	14	2,55	00819190014255	A 29
200	14	2,55	00819200014255	A 30
210	14	2,55	00819210014255	A 32
220	14	2,55	00819220014255	A 33
230	14	2,55	00819230014255	A 34
240	14	2,55	00819240014255	A 36
250	14	2,55	00819250014255	A 37
260	14	2,55	00819260014255	A 37
270	14	2,55	00819270014255	A 39
280	14	2,55	00819280014255	A 39
300	14	2,55	00819300014255	A 40
310	14	2,55	00819310014255	A 40

METAL DURO

B	H	S	REFERENCIA	PVP
60	14	2,55	00919060014255	A 40
80	14	2,55	00919080014255	A 47
100	14	2,55	00919100014255	B 2
120	14	2,55	00919120014255	B 7
130	14	2,55	00919130014255	B 8
140	14	2,55	00919140014255	B 11
150	14	2,55	00919150014255	B 12
160	14	2,55	00919160014255	B 15
170	14	2,55	00919170014255	B 16
180	14	2,55	00919180014255	B 19
190	14	2,55	00919190014255	B 20
200	14	2,55	00919200014255	B 23
210	14	2,55	00919210014255	B 25
220	14	2,55	00919220014255	B 26
230	14	2,55	00919230014255	B 29
240	14	2,55	00919240014255	B 31
250	14	2,55	00919250014255	B 32
260	14	2,55	00919260014255	B 34
270	14	2,55	00919270014255	B 37
280	14	2,55	00919280014255	B 39
300	14	2,55	00919300014255	B 43

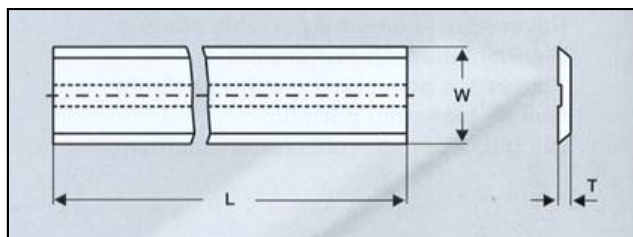

METAL DURO

B	H	S	REFERENCIA	PVP
60	13,6	1,80	00920060136018	A 24
80	13,6	1,80	00920080136018	A 29
100	13,6	1,80	00920110136018	A 34
110	13,6	1,80	00920110136018	A 36
120	13,6	1,80	00920120136018	A 40
130	13,6	1,80	00920130136018	A 43
140	13,6	1,80	00920140136018	A 44
150	13,6	1,80	00920150136018	A 46
160	13,6	1,80	00920160136018	A 50
180	13,6	1,80	00920180136018	B 2
190	13,6	1,80	00920190136018	B 3
200	13,6	1,80	00920200136018	B 5
230	13,6	1,80	00920230136018	B 8
240	13,6	1,80	00920240136018	B 9
250	13,6	1,80	00920250136018	B 10
260	13,6	1,80	00920260136018	B 12